

# Wiringkit



D	Einbauanleitung
GB	Installation instructions
F	Consignes de montage
NL	Montagehandleiding
DK	Montagevejledning
N	Monteringsinstruksjon
S	Installationsanvisning
FIN	Asennusohje
I	Istruzioni per il montaggio
E	Instrucciones de montaje
P	Instruções de montagem
GR	Οδηγίες εγκατάστασης
CZ	Návod k montáži
SLO	Navodilo za vgradnjo
SK	Montážny návod
PL	Instrukcja montażu
TR	Montaj talimatı
H	Beépítési útmutató
HR	Upute o ugradnji
BUL	Инструкция за монтаж
RO	Instrucțiuni de montaj
RU	Инструкция по монтажу и установке
LT	Montavimo informacija
LV	Iemontēšanas pamācība
EST	Paigaldusjuhend

## 703503

BMW

- **1-Serie 5-Türer / Door**      **F20**    03/14 >> 06/19
- **1-Serie 3-Türer / Door**      **F21**    03/14 >> 06/19
- **2-Serie Coupe**                      **F22**    03/14 >>
- **2-Serie Cabrio**                        **F23**    03/14 >>

LHD + RHD

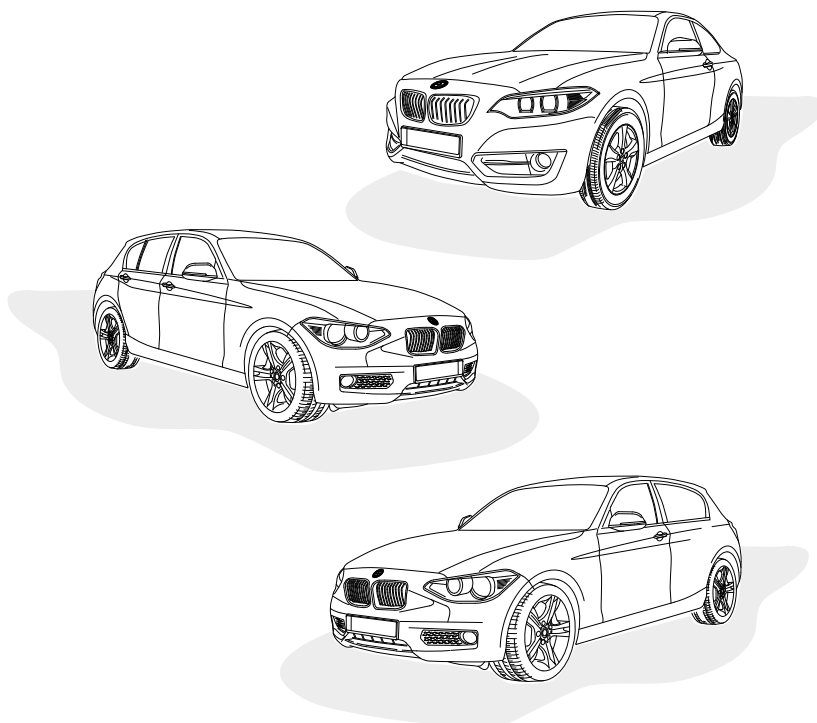
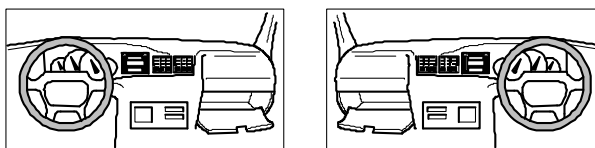

# OVERVIEW

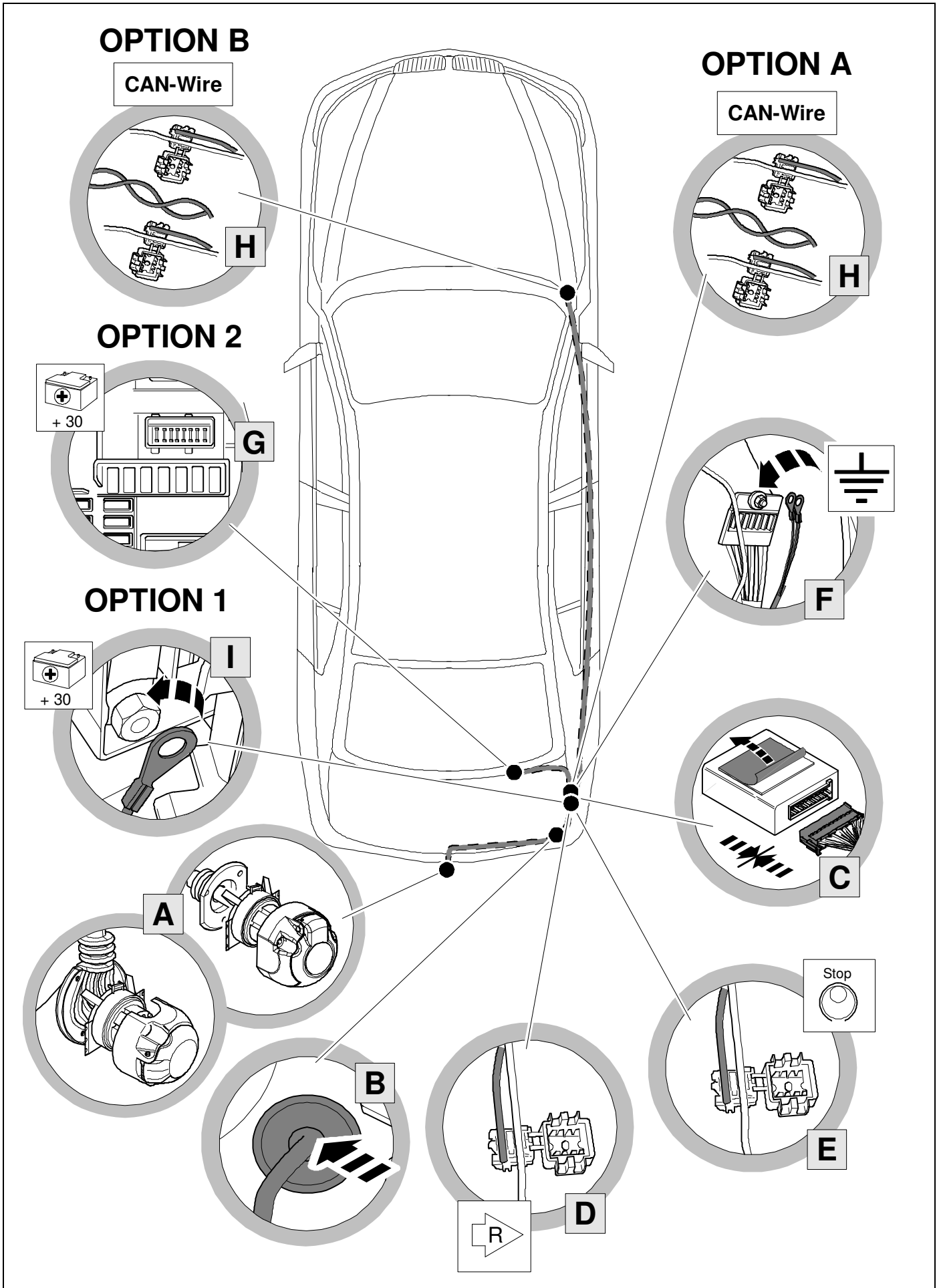

# KIT

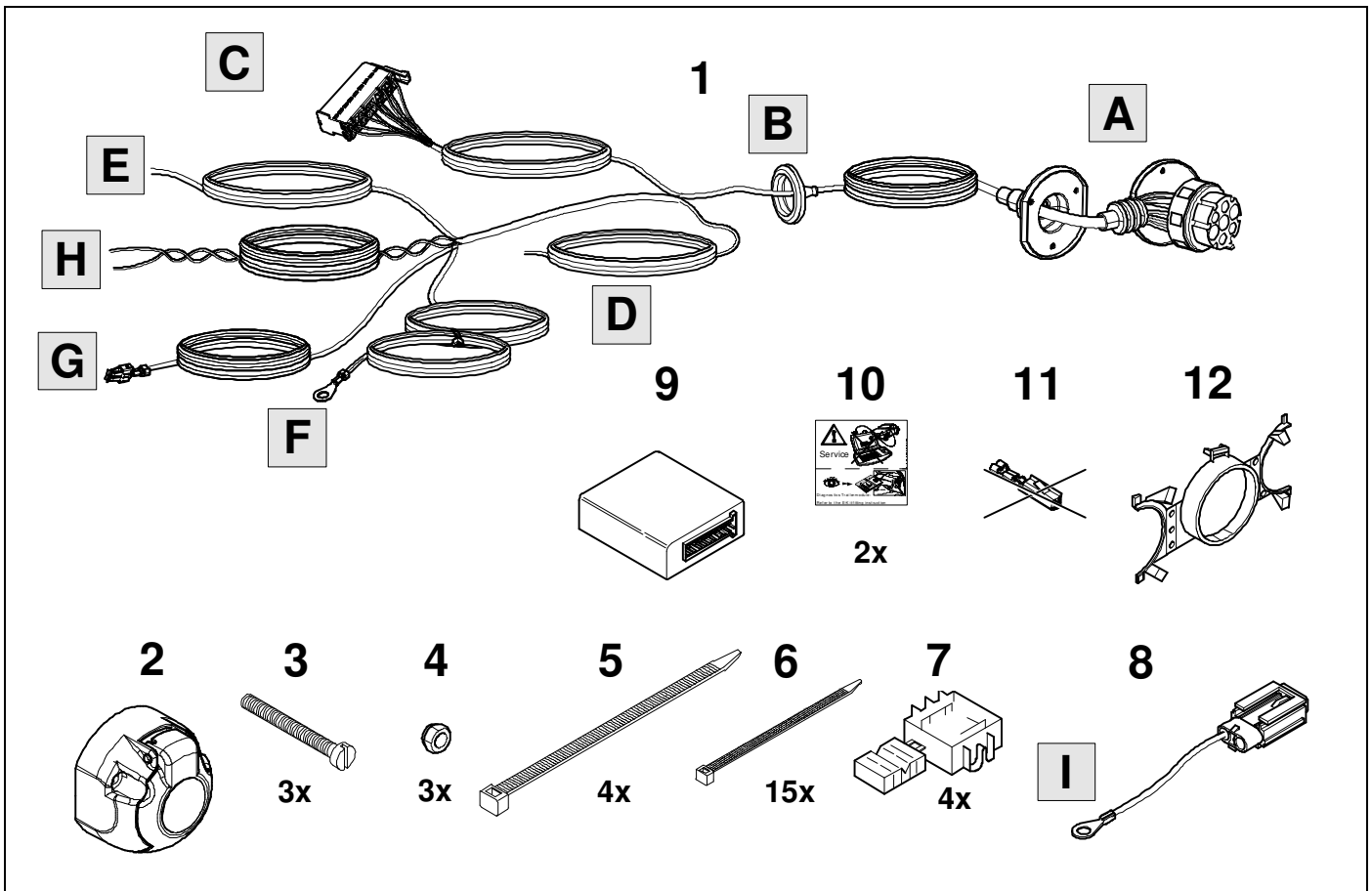

# TOOLS

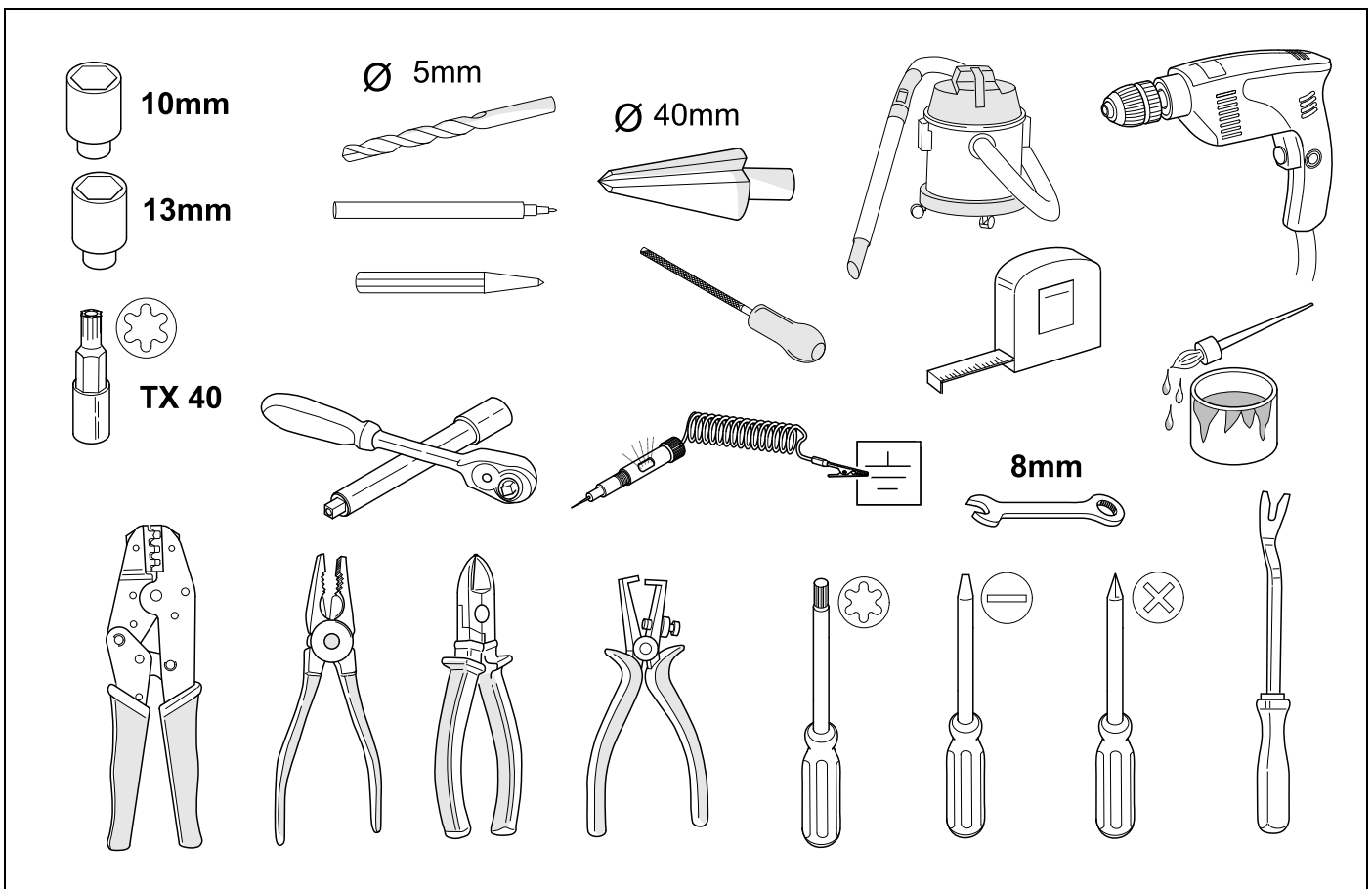

1



# 2 REMOVE

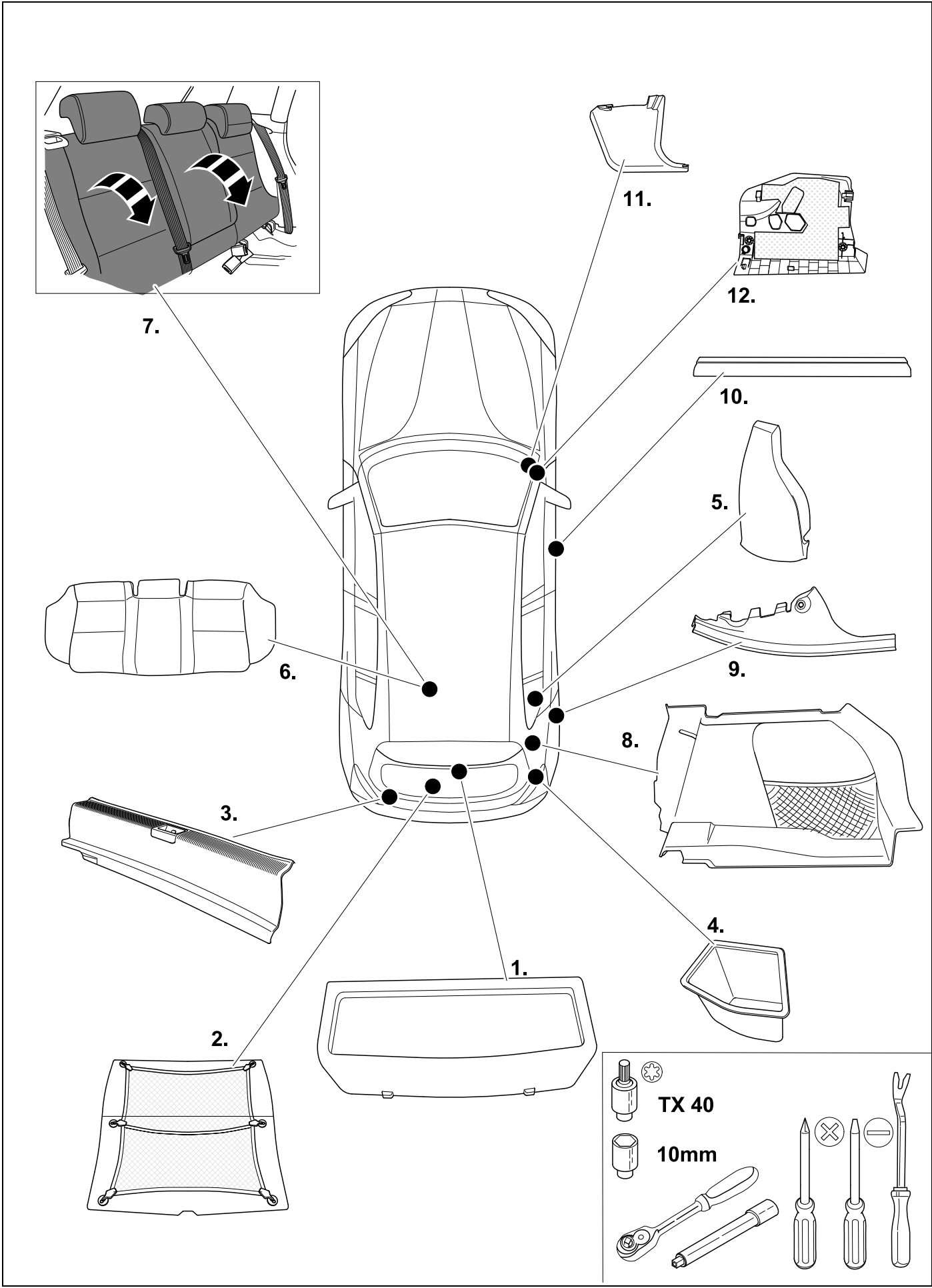

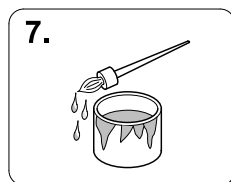
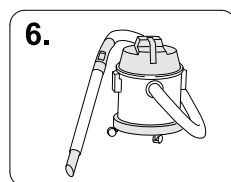
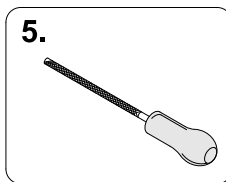
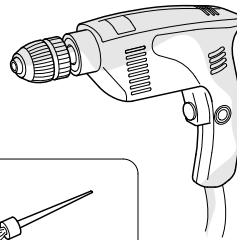
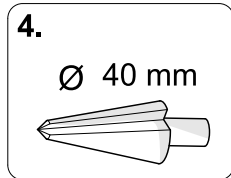
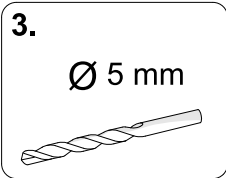
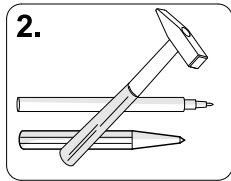
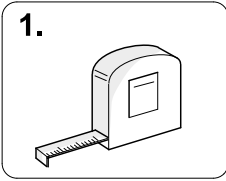
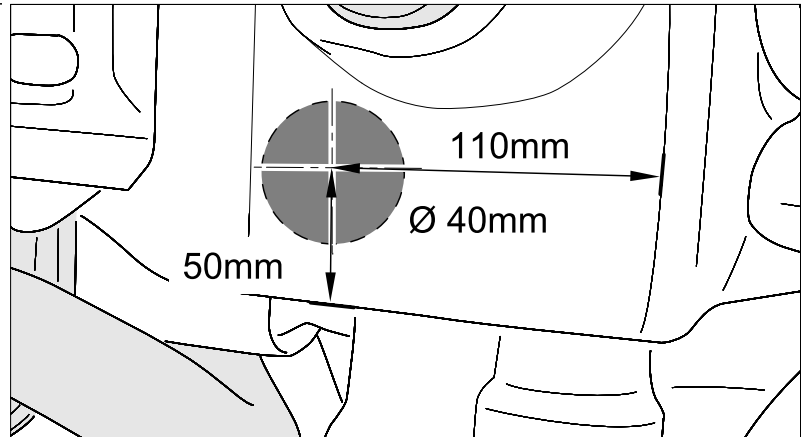
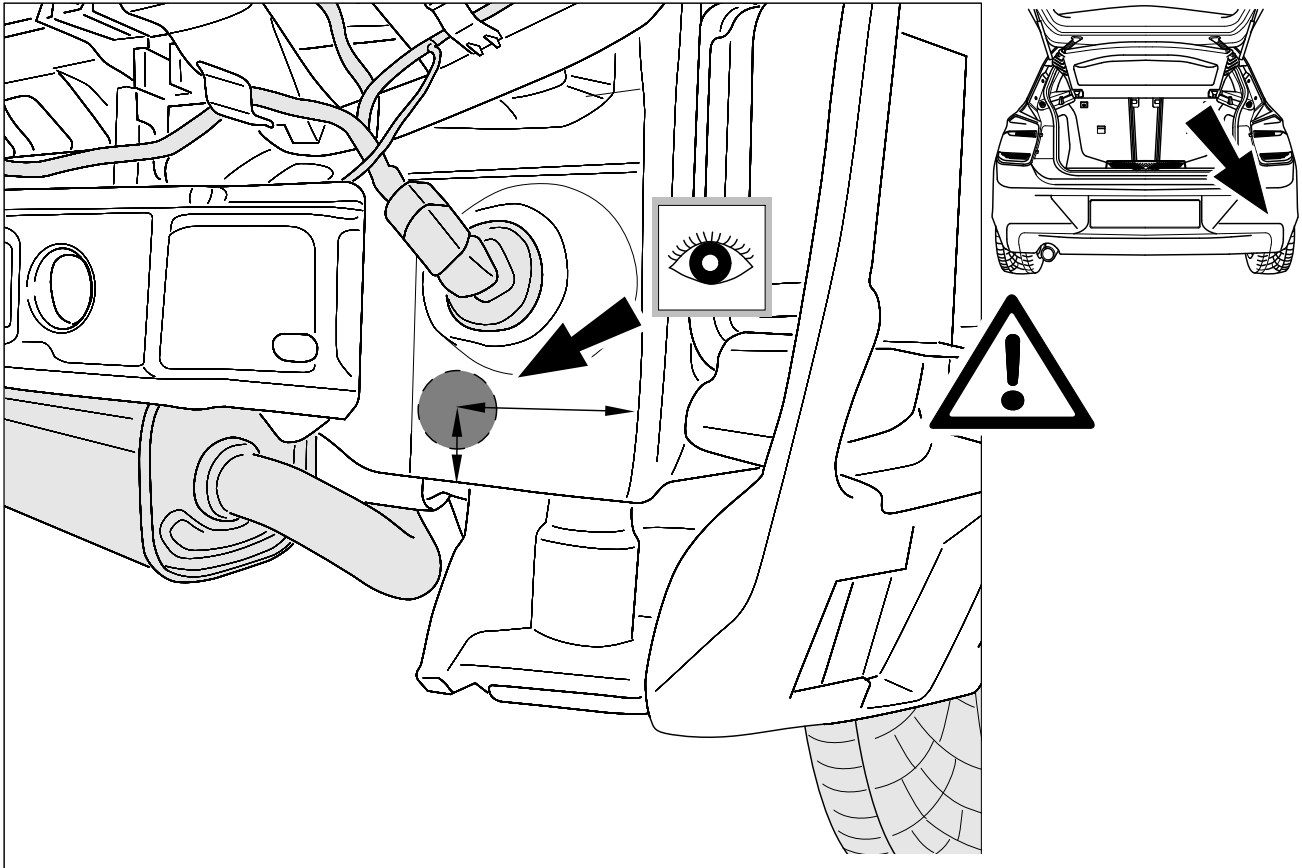

4

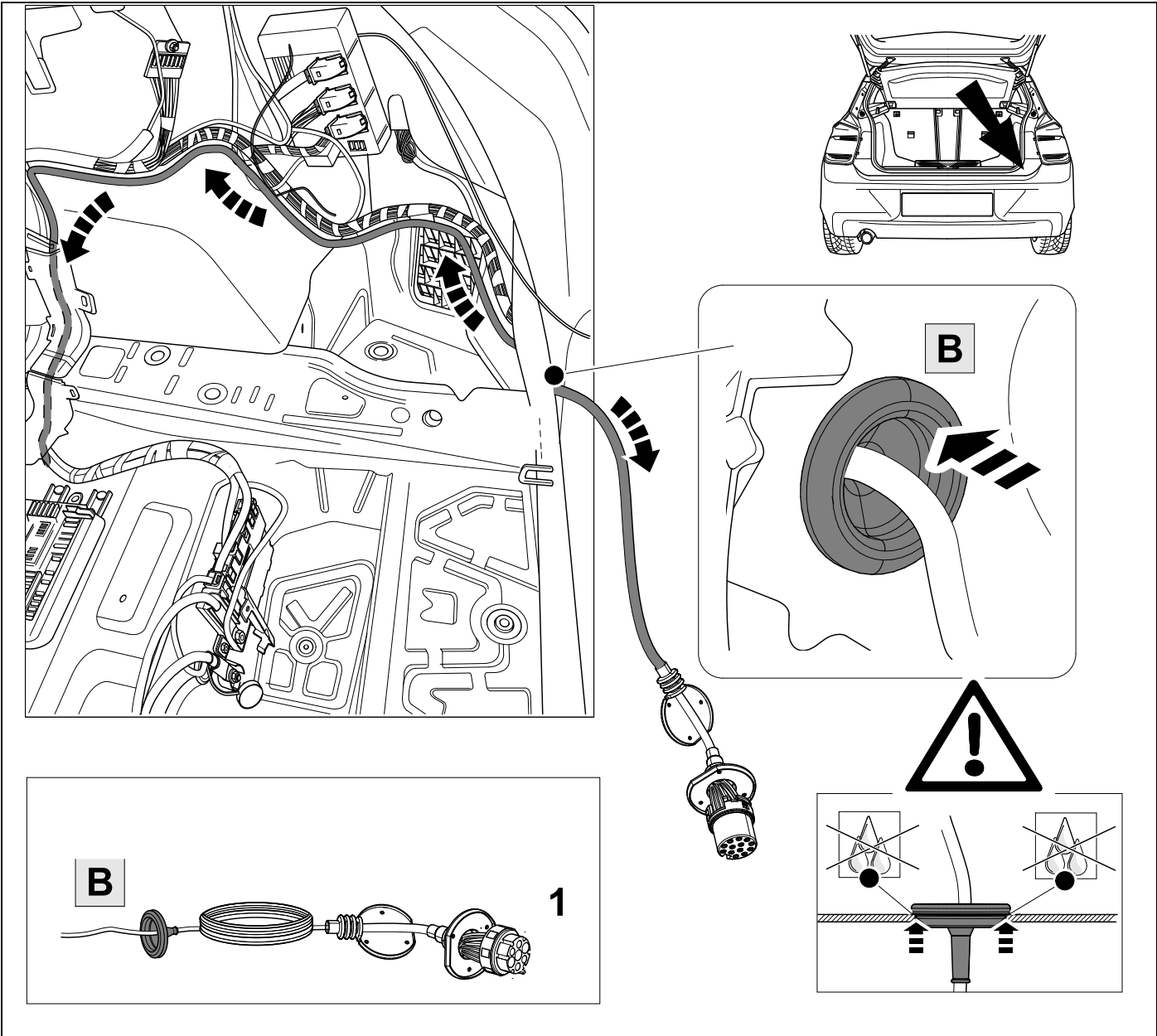

5

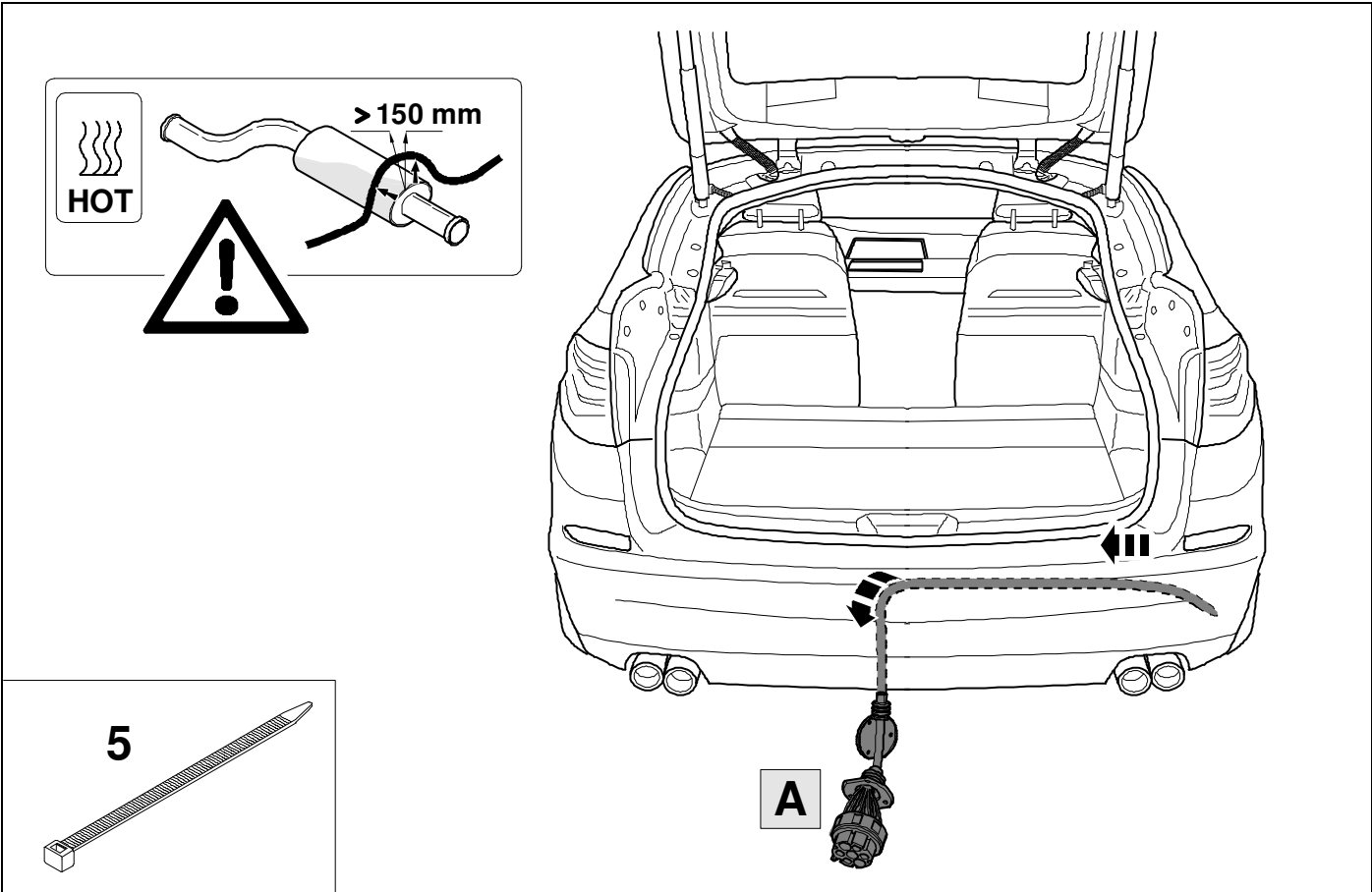

6

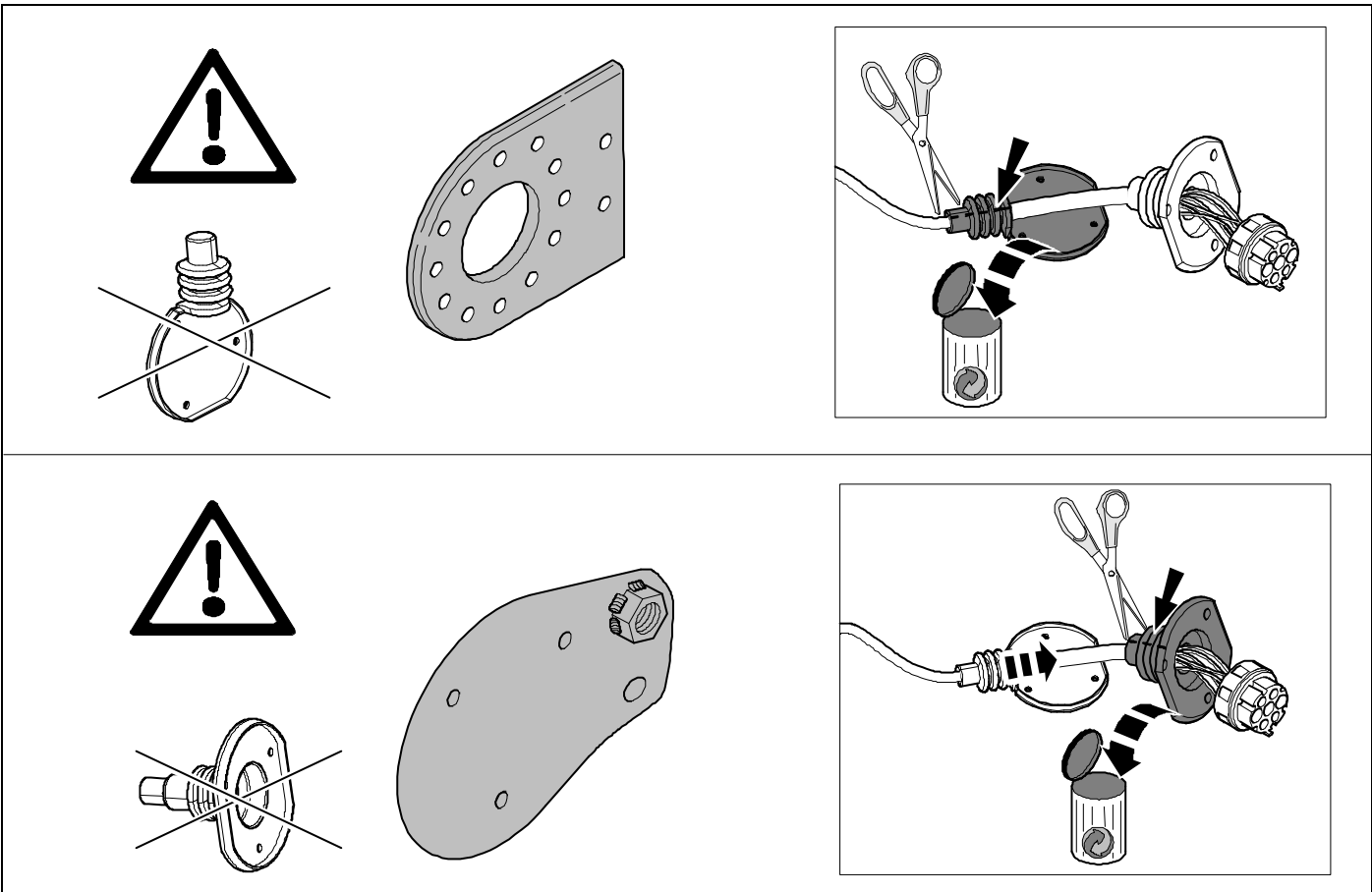



7



9

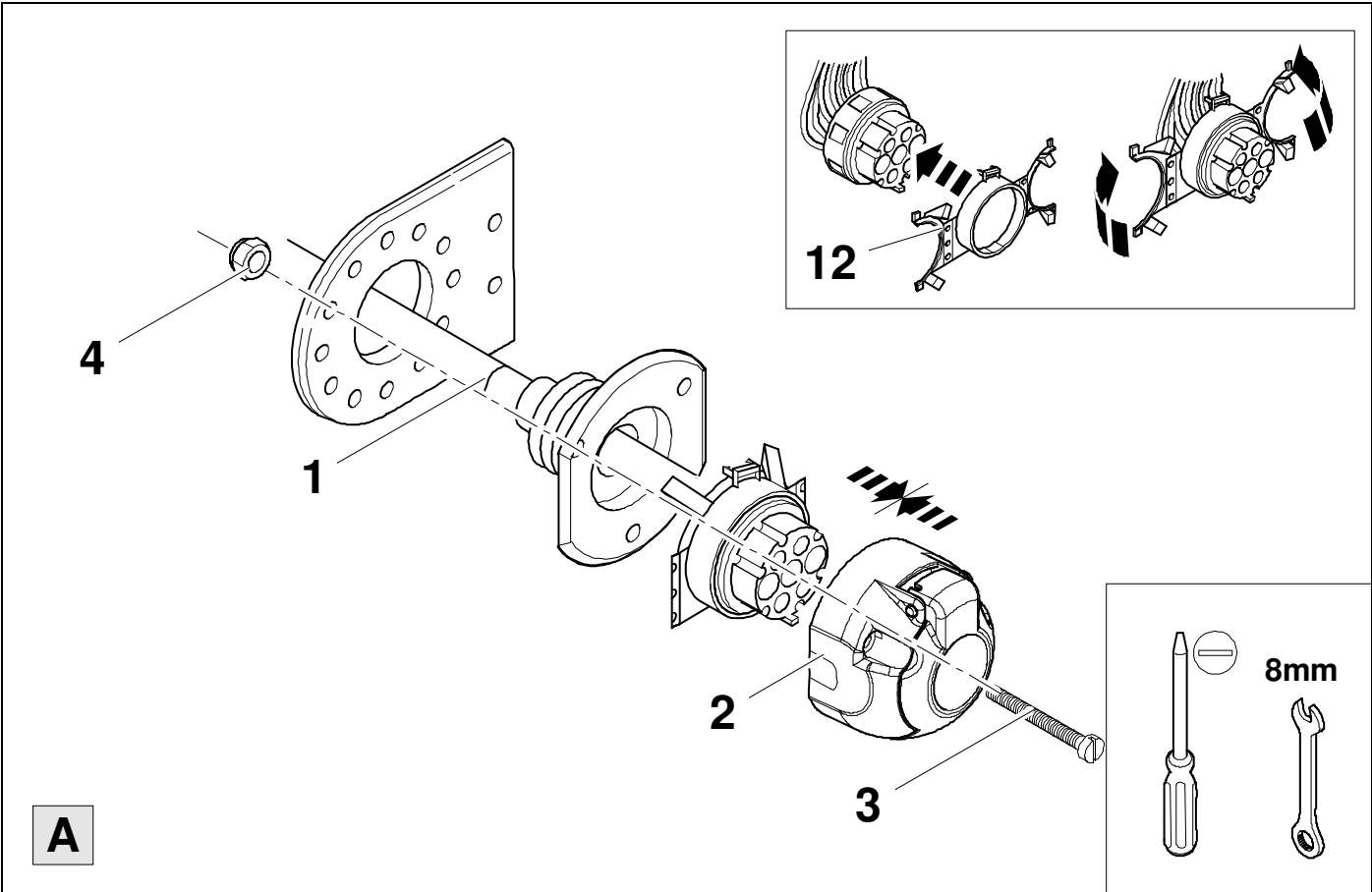

8



9

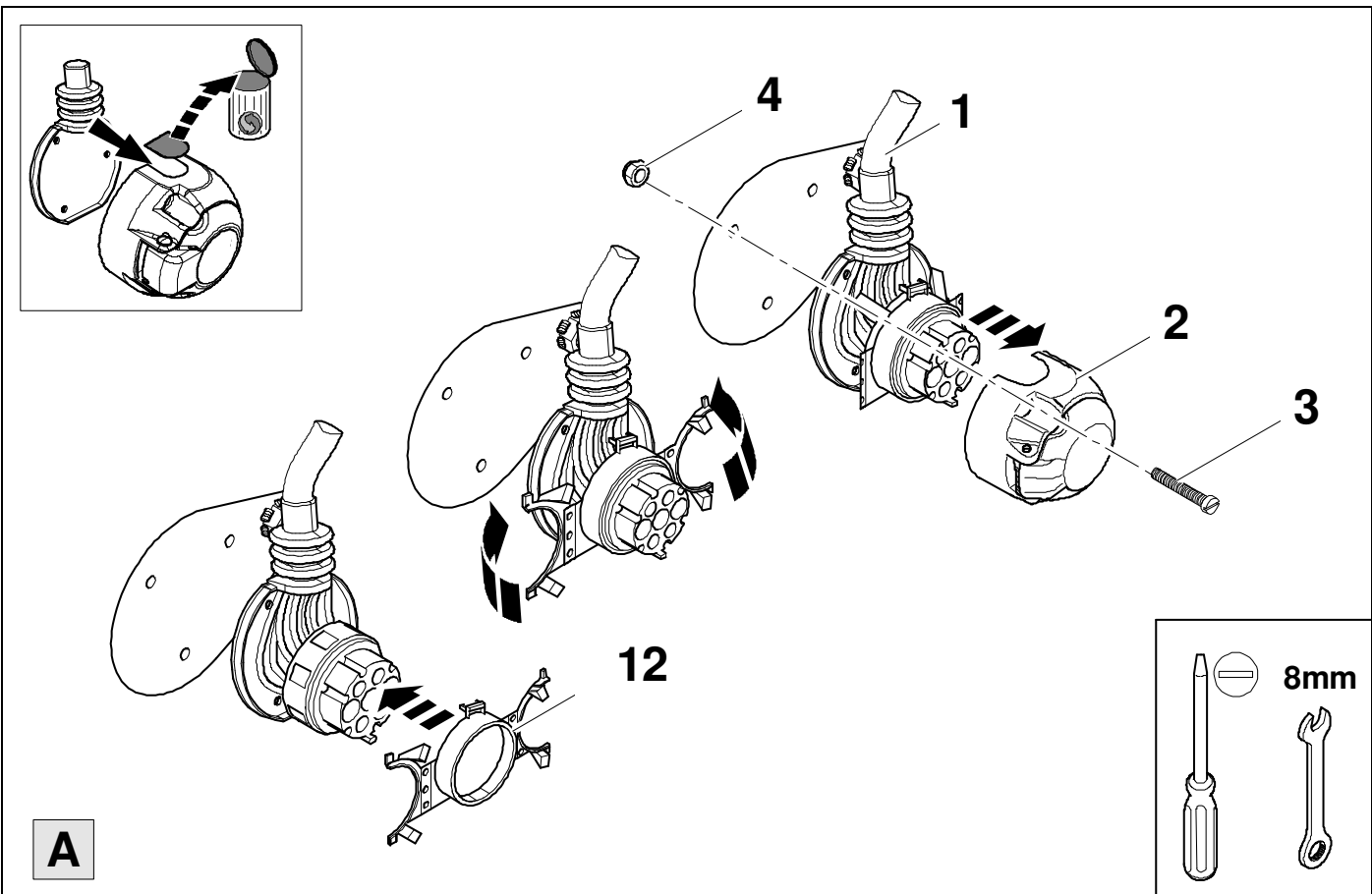



<b>1/L</b>	<b>bk/wh</b>	
<b>2/54g</b>	<b>gy</b>	
<b>3/31</b>	<b>wh/bn</b>	
<b>4/R</b>	<b>bk/gn</b>	
<b>5/58R</b>	<b>gy/rd</b>	
<b>6/54</b>	<b>bk/rd</b>	
<b>7/58L</b>	<b>gy/bk</b>	

10	bk	wh	gy	gn	rd	bu	ye	bn	pu	or	no
<b>(D)</b>	schwarz	weiß	grau	grün	rot	blau	gelb	braun	violett	orange	nicht belegt
<b>(GB)</b>	black	white	grey	green	red	blue	yellow	brown	purple	orange	not occupied
<b>(F)</b>	noir	blanc	gris	vert	rouge	bleu	jaune	brun	violet	orange	inutilisé
<b>(NL)</b>	zwart	wit	grijs	groen	rood	blauw	geel	bruin	violet	oranje	niet aangesloten
<b>(DK)</b>	sort	hvid	grå	grøn	rød	blå	gul	brun	violet	orange	ikke anvendt
<b>(N)</b>	svart	hvit	grå	grønn	rød	blå	gul	brun	fiolett	oransje	ikke i bruk
<b>(S)</b>	svart	vit	grå	grön	röd	blå	gul	brun	violett	orange	ej använd
<b>(FIN)</b>	musta	valkoinen	harmaa	vihreä	punainen	sininen	keltainen	ruskea	violetti	oranssi	ei varattu
<b>(I)</b>	nero	bianco	grigio	verde	rosso	blu	giallo	marrone	viola	arancione	libero
<b>(E)</b>	negro	blanco	gris	verde	rojo	azul	amarillo	marrón	violeta	anaranja-do	no ocupado
<b>(P)</b>	preto	branco	cinzento	verde	vermelho	azul	amarelo	castanho	violeta	laranja	não ocupado
<b>(GR)</b>	μαύρος	λευκός	Γκρι	πράσινος	κόκκινος	μπλε	κίτρινος	καφέ	Μωβ	πορτοκαλί	δεν είναι κοτ ειλημμένος
<b>(PL)</b>	czarny	biały	szaro	zielony	czerwony	niebiesko	żółty	brazowy	fioletowy	pomarańczowy	wolny
<b>(CZ)</b>	černý	bílý	šedý	zelený	červený	modrý	žlutý	hnědý	fialový	oranžový	neobsazen
<b>(TR)</b>	siyah	beyaz	gri	yeşil	kırmızı	mavi	sarı	kahverengi	mor	portakal rengi	boş
<b>(H)</b>	fekete	fehér	szürke	zöld	piros	kék	sárga	barna	ibolyakék	narancssárga	nem foglalt
<b>(HR)</b>	crno	bijelo	sivo	zeleno	crveno	plavo	zuto	smeđe	ljubičasto	narandasto	nije zauzeto
<b>(BUL)</b>	черен	бял	сив	зелен	червен	син	жълт	кафяв	виолетов	оранжев	свободно
<b>(RO)</b>	negru	alb	gri	verde	roșu	albastru	galben	maro	violet	portocaliu	liber
<b>(RU)</b>	черный	белый	серый	зеленый	красный	голубой	желтый	коричневый	пурпурный	оранжевый	свободно
<b>(LT)</b>	juoda	balta	pilka	žalia	raudona	mėlyna	geltona	ruda	purpurinė	oranžinė	laisva
<b>(LV)</b>	melna	balta	pelēka	zaļa	sarkana	zila	dzeltena	brūna	purpur-sarkana	oranža	brīvs
<b>(EST)</b>	must	valge	hall	roheline	punane	sinine	kollane	pruun	purpur-punane	oraanz	vaba
<b>(SLO)</b>	črna	bela	siva	zelena	rdeča	modra	rumena	smeđ	vijoličast	oranžen	ni zasedeno
<b>(SK)</b>	čierny	biely	šedý	zelený	červený	modrý	žltý	hnědý	fialový	pomaraňový	neobsadený

11

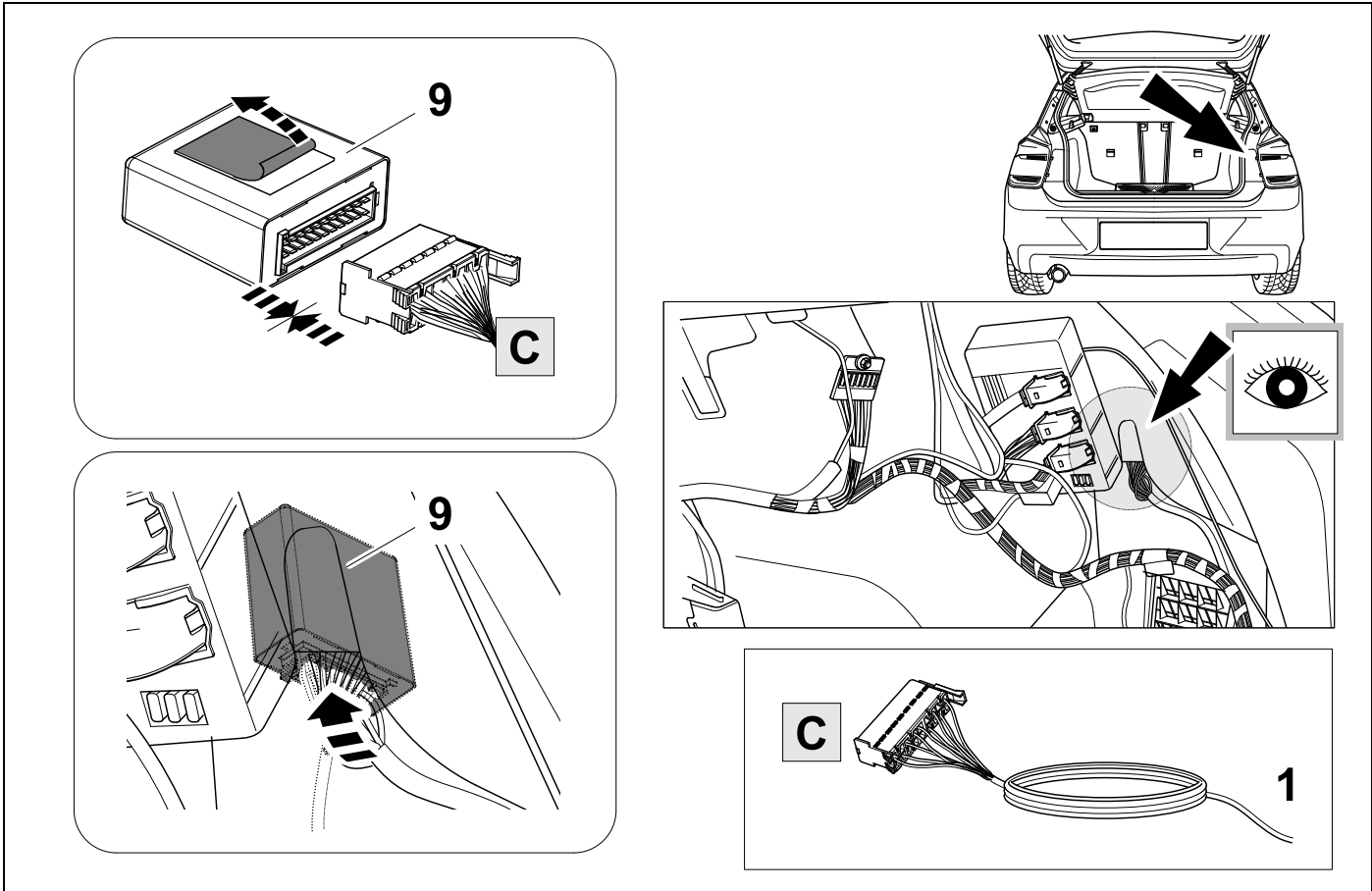

12

👁️ ⇒ 10

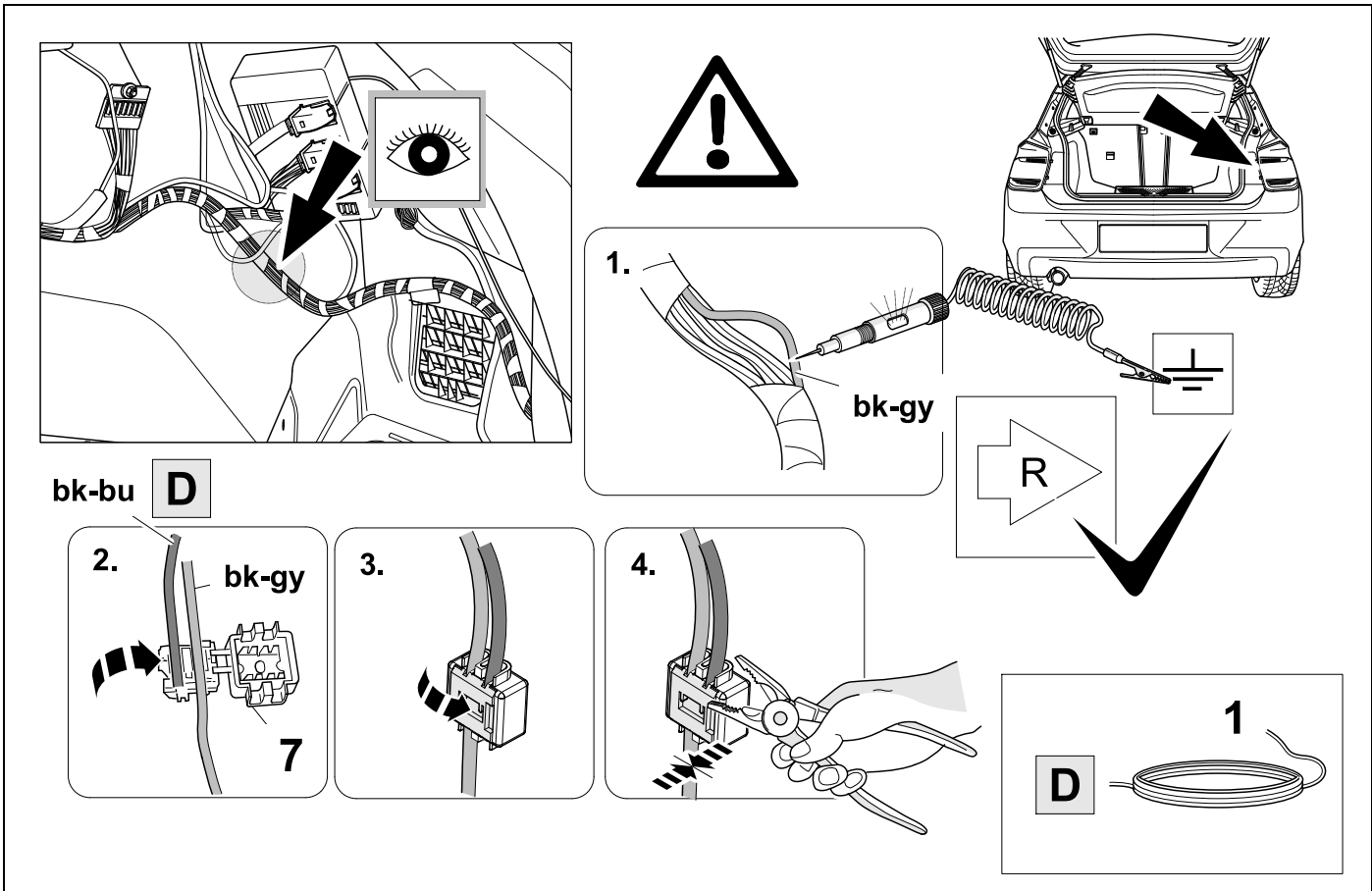

13



10

**1.** **bk-ye**

**2.** **bk-ye**

**3.** **7**

**4.** **1**

**E** **1**

**Stop**

14

**1**

**F**

**1**

**10 mm**

15

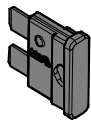

20A F113

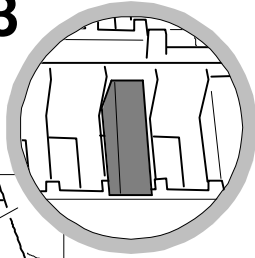

OPTION 1

16

19 - 33

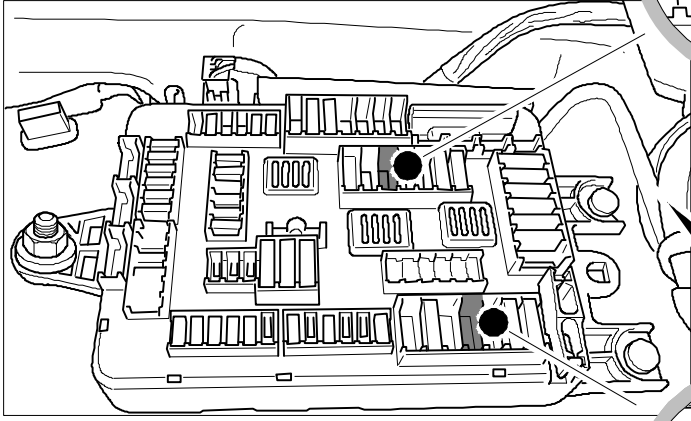

F113

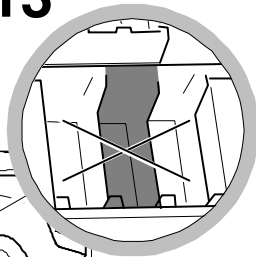

OPTION 2

17 - 33

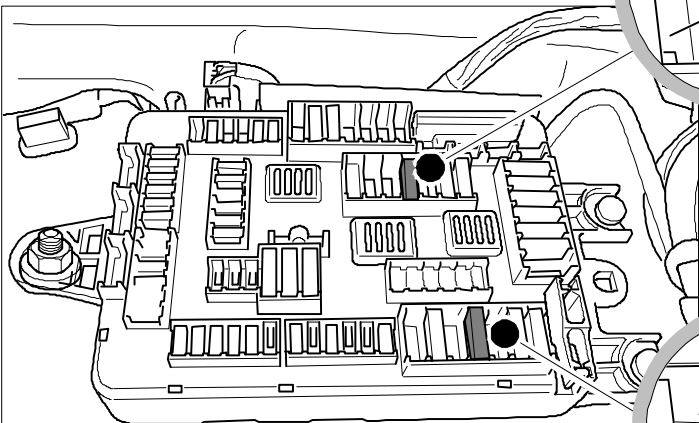

16

# OPTION 1



30

rd 20A rd

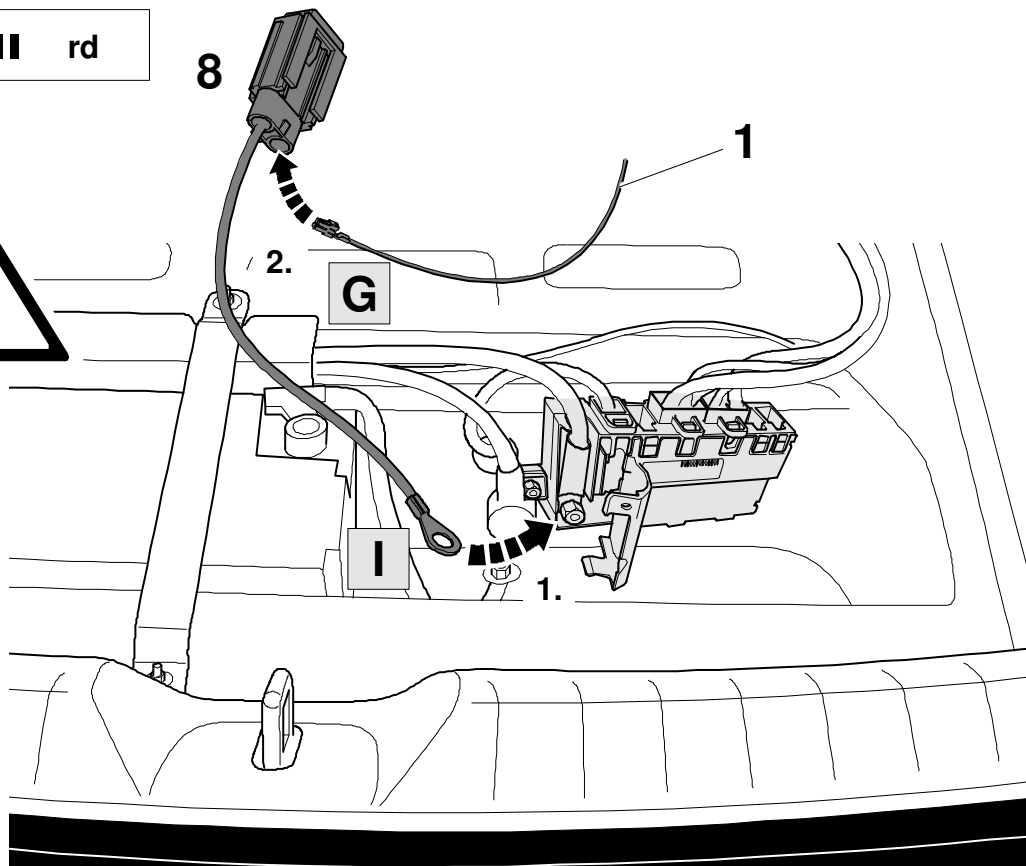
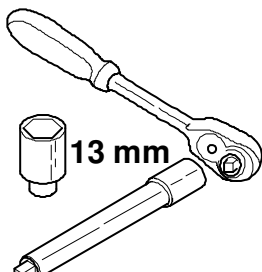
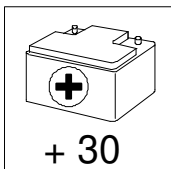

17

# OPTION 2



10

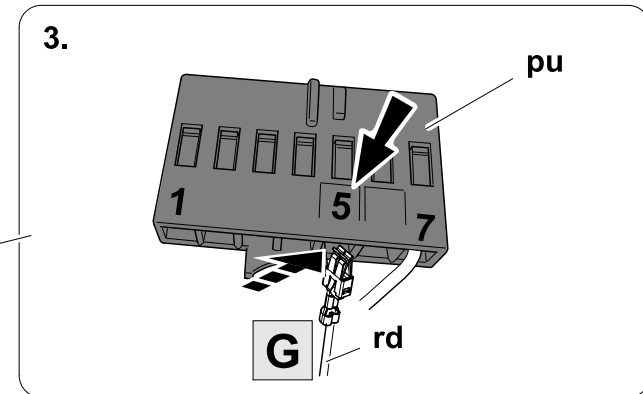
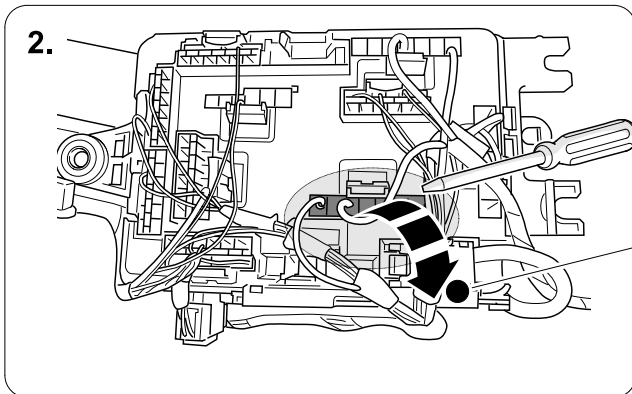
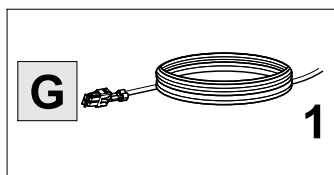
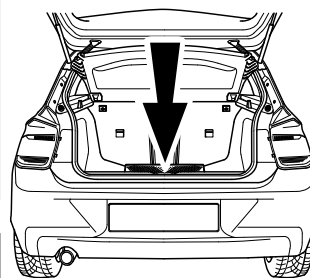
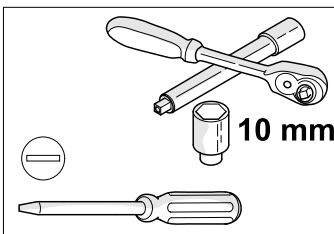
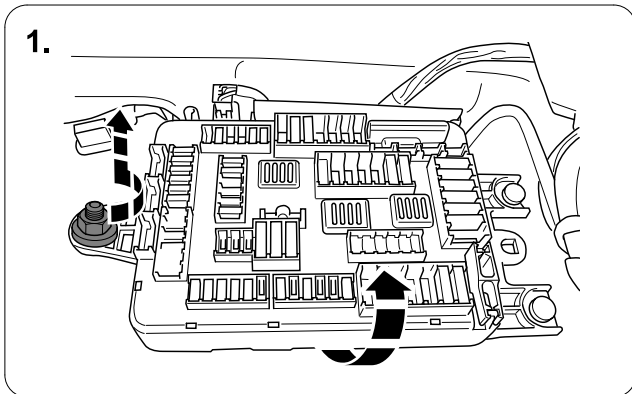

18

OPTION 2



30

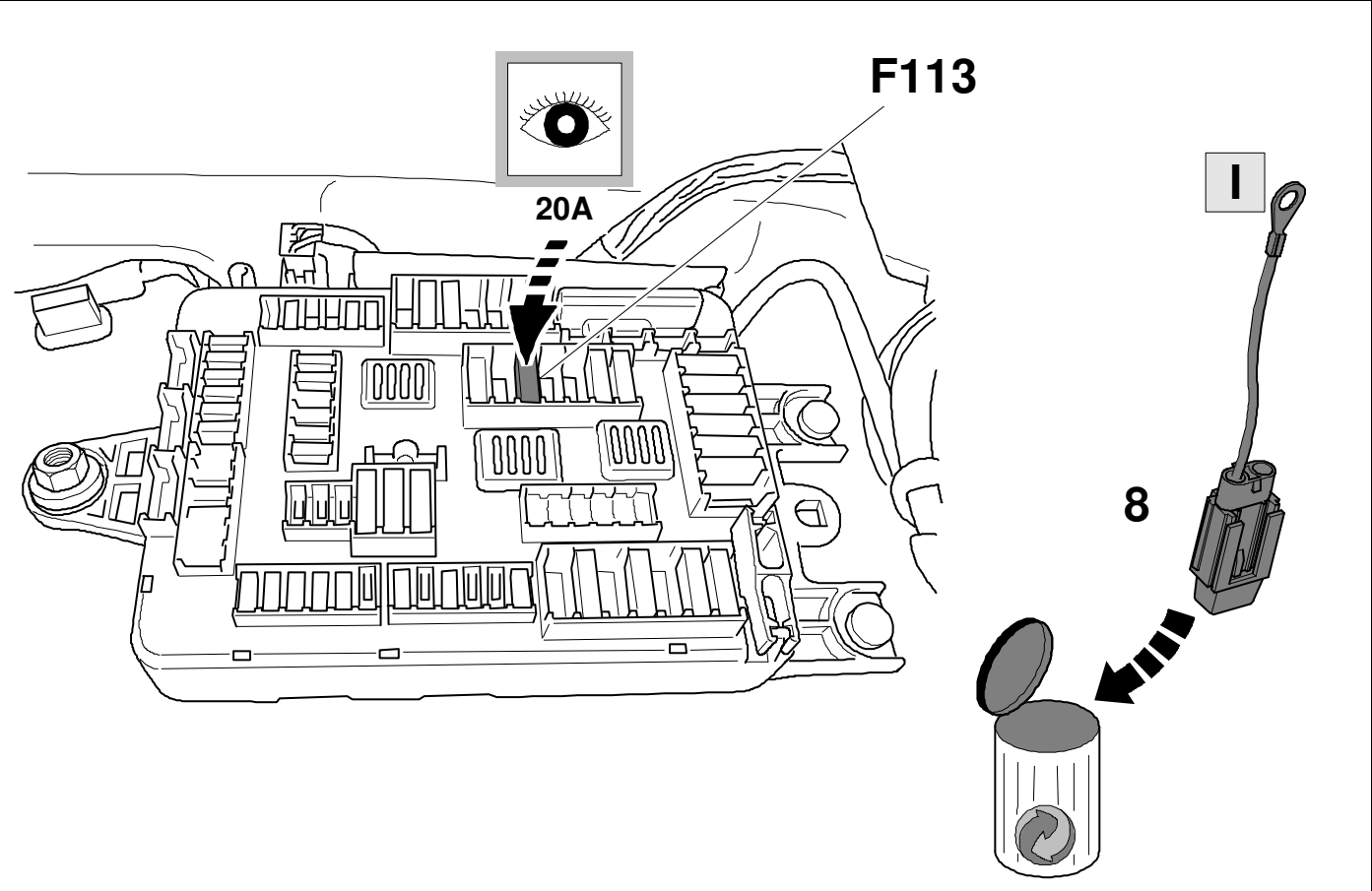

19

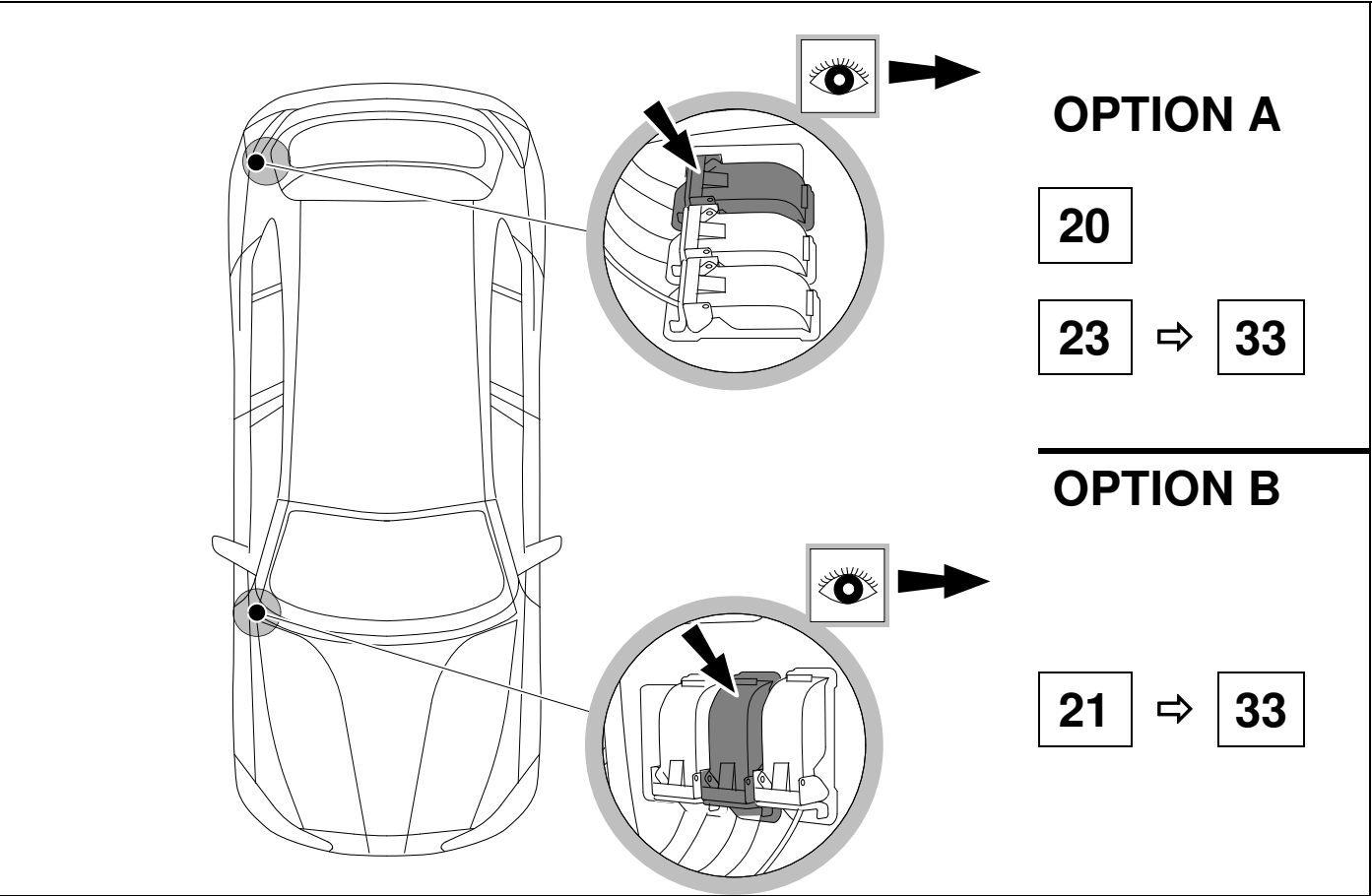

20

# OPTION A

👁️ ⇒ 10

**CAN Wire**

ye-rd  
ye-bn

**H**

1. ye-rd  
wh

2.

3.

4. ye-bn  
bk

5.

6.

**H** 1

Detailed description: This diagram illustrates the installation of a CAN wire for Option A. It includes a main view of the wire harness, a circular inset showing the wire being inserted into a connector, and a rear view of the car with an arrow pointing to the trunk area. Six numbered steps (1-6) show the process of stripping the wire, inserting it into the connector, and crimping it. A separate box shows a coil of wire labeled 'H' and '1'.

21

# OPTION B

👁️ ⇒ 10

**H**

**H** 1

**6**

bk

Detailed description: This diagram illustrates the installation of a CAN wire for Option B. It includes a top view of the car with an arrow pointing to the driver's side door area, a circular inset showing the wire being inserted into a connector, and a side view of the car with an arrow pointing to the rear door area. A separate box shows a coil of wire labeled 'H' and '1', and another box shows a long thin component labeled '6'. The label 'bk' is also present near the circular inset.





**PIN 49 ye-rd**

**CAN Wire**

**ye-bn PIN 50**

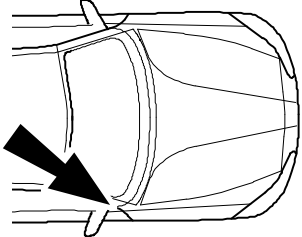
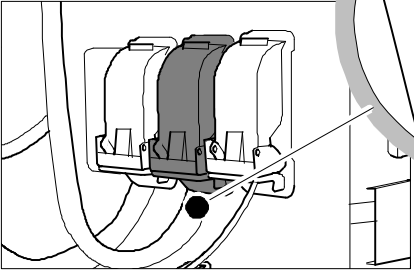
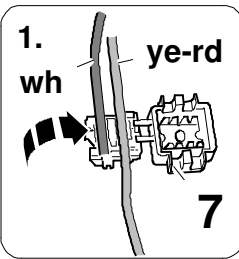
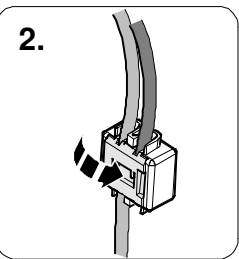
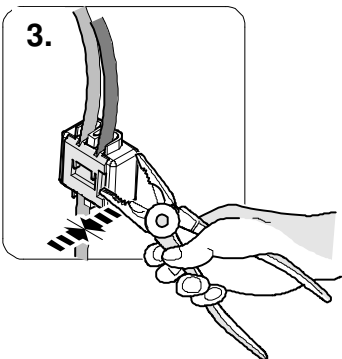
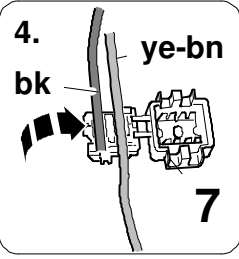
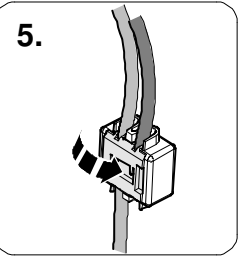
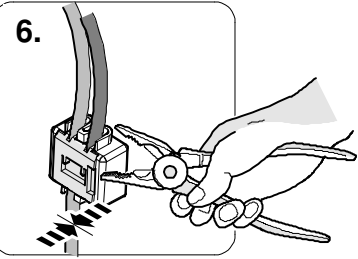
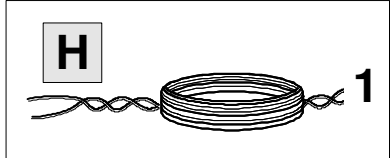
**H**

**H**





**H**

**H**

**H**

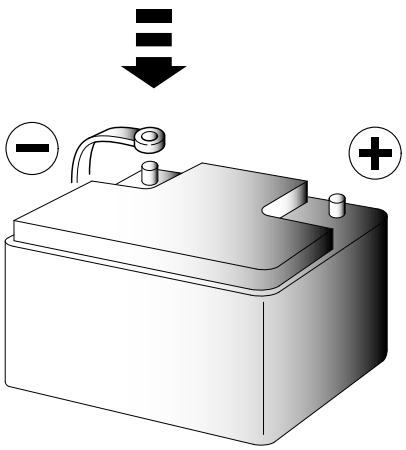
**H**

**H**

**⚡**

**24 CHECK**

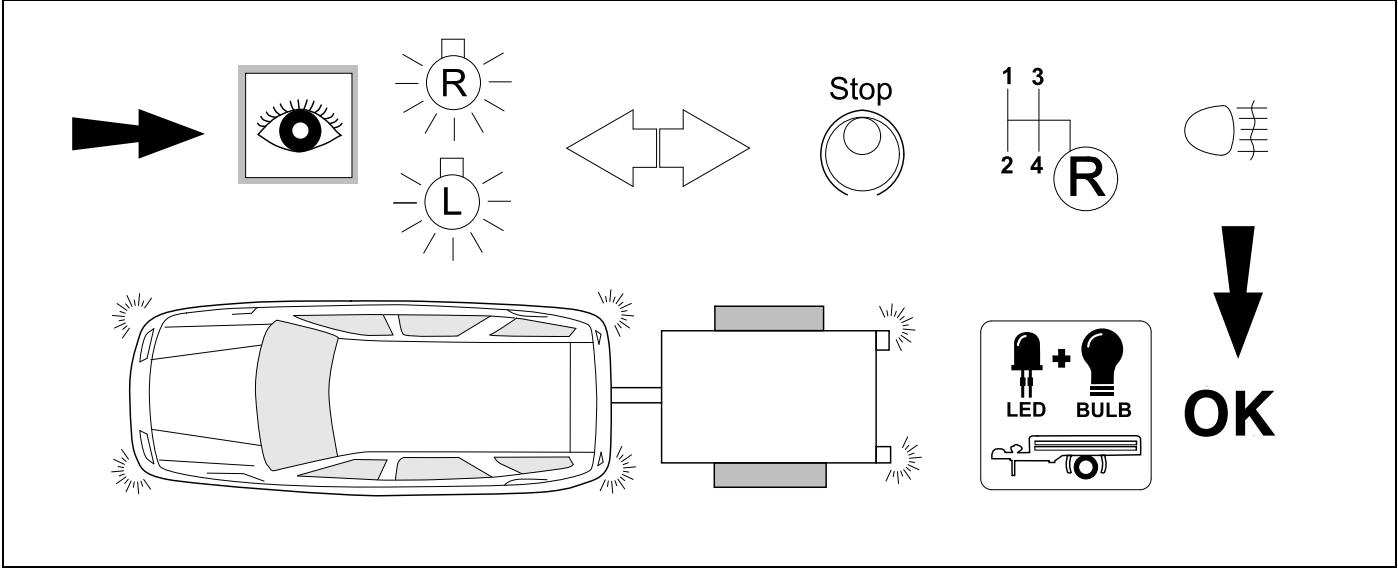

**25 OPTIONAL**



**Trailer Simulator**  
for 7p and 13p sockets  
**765069**

**26 CHECK**

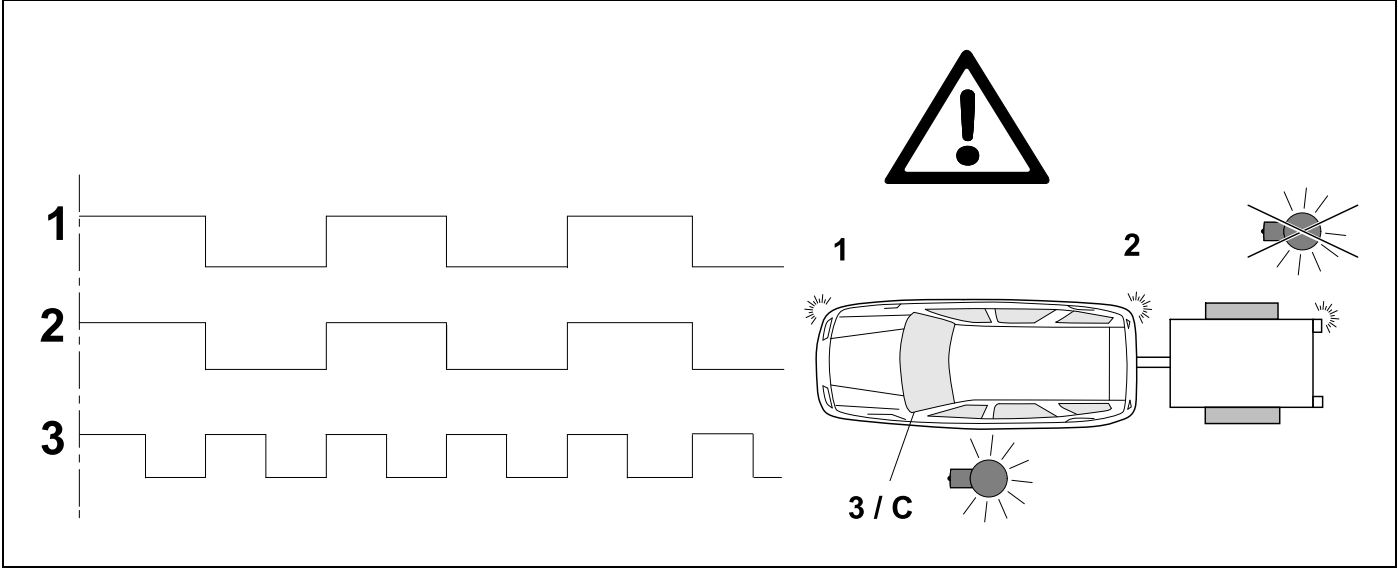

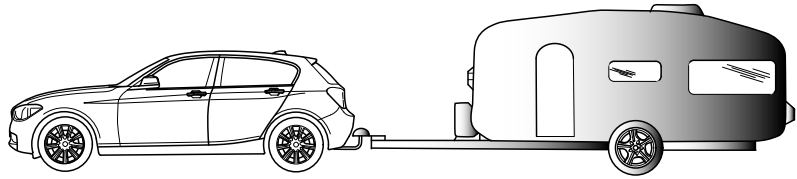
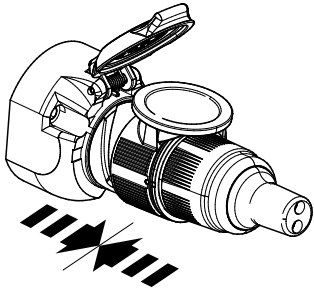

OPTION 1

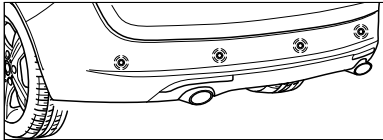

No Coding



OPTION 2

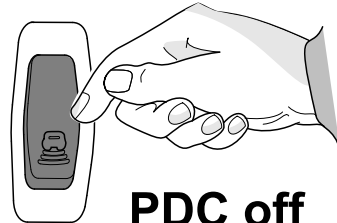
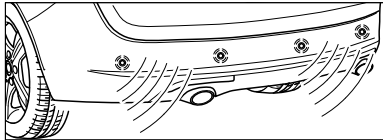

PDC off



OPTION 3

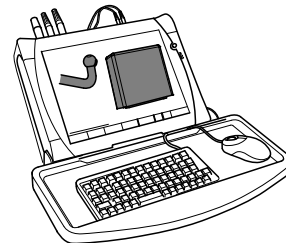
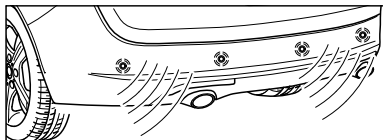

BMW Service ISTA/P  
Initialize Trailer Module

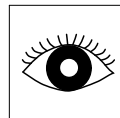

28

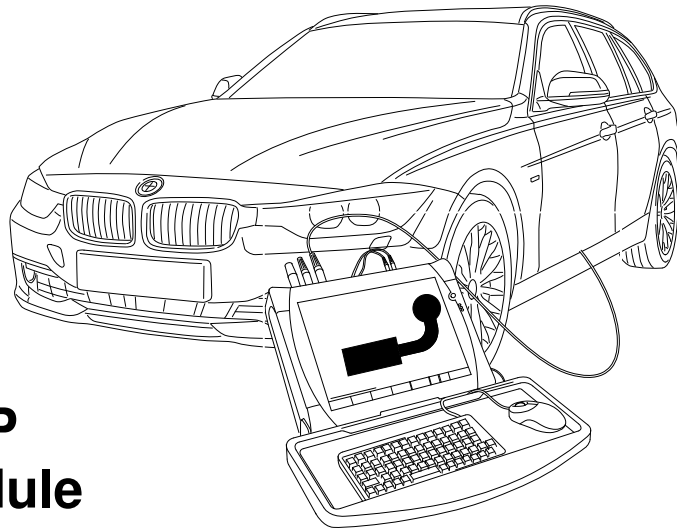

## BMW Service ISTA/P Initialize Trailer Module

D

### Codierung bitte wie folgt durchführen:

- Computer mit Fahrzeug verbinden
- ISTA/P starten
- Klicke „Umrüstungen/Nachrüstungen“
- Maßnahme plan Abfragen
- Klicke auf „Codierungen (Ethernet)“
- Aktionen Programmier Nachbereitung Abfragen
- Abschlussbericht Überprüfen

**Nach erfolgreicher Freischaltung wird im Anhängerbetrieb auch die rückwärtige Einparkhilfe automatisch deaktiviert!**

GB

### Please effect coding as follows:

- Connect computer to vehicle
- Start ISTA/P
- Click “Modification / Upgrades”
- Scan Action plan
- Click „Coding (Ethernet)“
- Scan Action program follow-up
- Final report checking

**After the effected connection, the rear park assist system will also automatically be deactivated in trailer operation!**

F

### Veillez effectuer le codage comme indiqué :

- Connecter l'ordinateur au véhicule
- ISTA/P
- Cliquez sur Modifications / Mise à jour
- Action correctives
- Cliquez sur Codage (Ethernet)
- Programmation des actions de suivi
- Vérifiez le Rapport final

**Après le codage, lors détection de la présence remorque, l'assistance d'aide au stationnement est automatiquement désactivée !**

I

### Effettuare la codifica come segue:

- Collegare il computer al veicolo
- Avviare ISTA/P
- Digitare „Modifiche/Aggiornamenti“
- Scansione programma d'intervento
- Digitare „Codifica (Ethernet)“
- Scansione programma d'intervento successivo
- Verificare il rapporto finale

**Dopo la codifica il sistema di assistenza al parcheggio sarà automaticamente disattivato quando rilevata la presenza del rimorchio**

E

### Por favor efectúe la codificación del vehículo de la siguiente manera:

- Conectar el ordenador con el vehículo
- Inicializar ISTA/P
- Hacer clic en Modificaciones / Actualizaciones
- Acciones Correctivas
- Hacer clic en Codificación (Ethernet)
- Programación de las acciones de seguimiento
- Verificar Informe Final

**¡Después de la codificación, cuando se detecta el remolque, los sensores de aparcamiento se desconectan de manera automática!**

NL

### Graag codering als volgt toepassen:

- Sluit computer aan op het voertuig
- Start ISTA/P
- Click “Modification / Upgrades”
- Scan Action plan
- Click „Coding (Ethernet)“
- Scan Action program follow-up
- Final report checking

**Na aanmelding zal het PDC systeem automatisch gedeactiveerd worden indien er trailer achter het voertuig zal worden geplaatst**



**Need help programming this wiringkit?**

If possible, we provide tips in our manuals on how the vehicle can be coded. It is always possible that more or different coding steps are required for your specific vehicle. That is why we recommend the use of Jifeline.

Jifeline codes your vehicle online with the most up to date knowledge.

30 Information Service



16

+

18

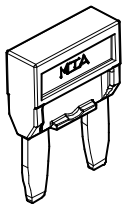

20A

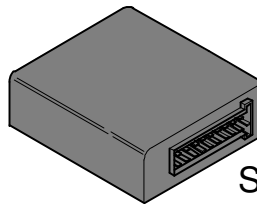
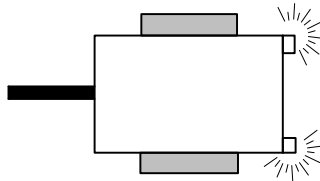

Stop

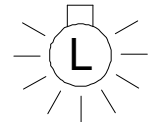
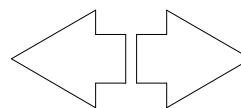
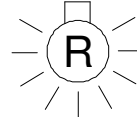
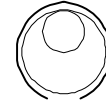

31

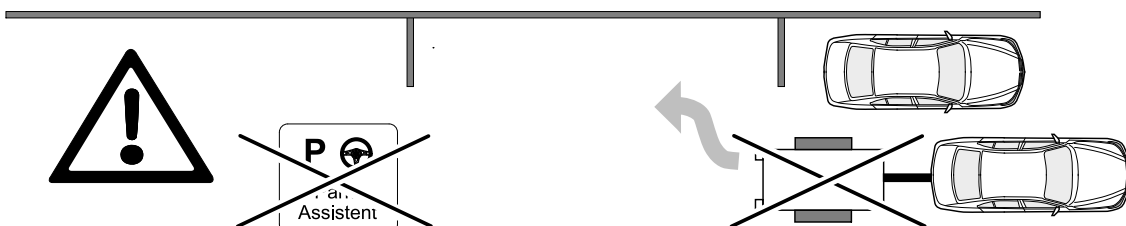
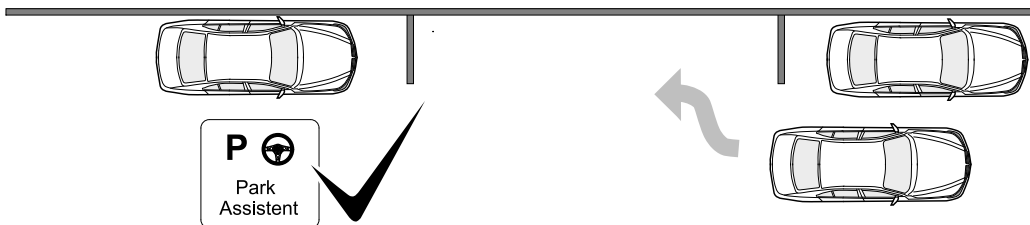

**32** OPTIONAL

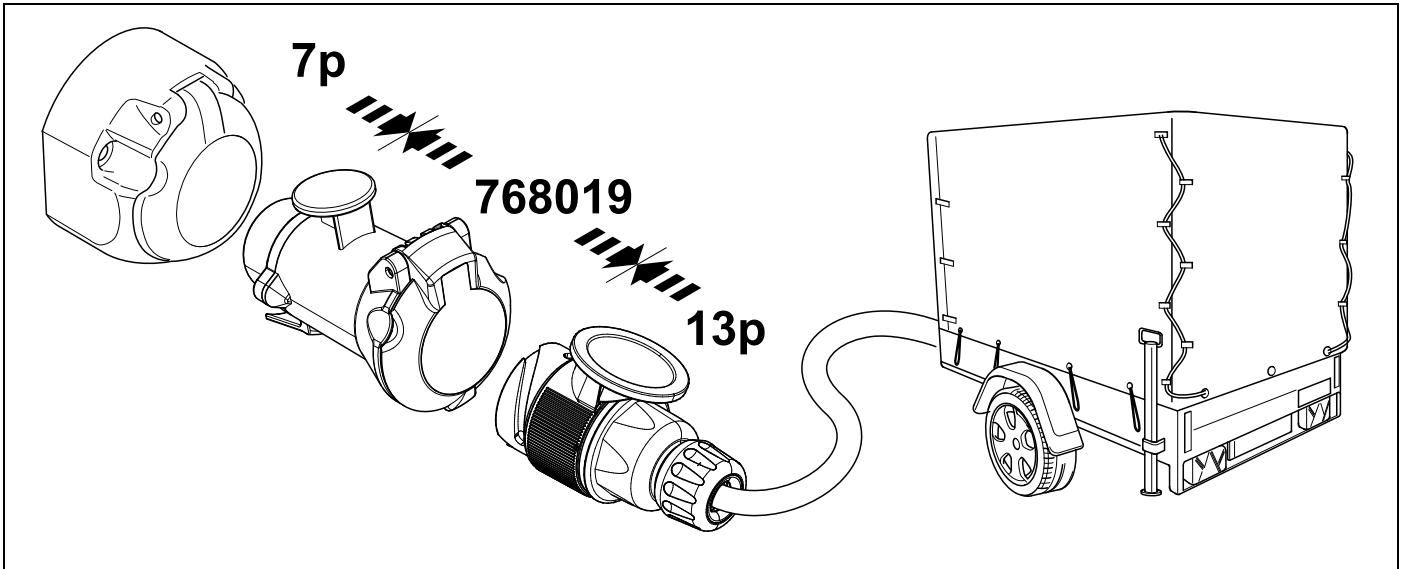

**33** PLEASE NOTICE

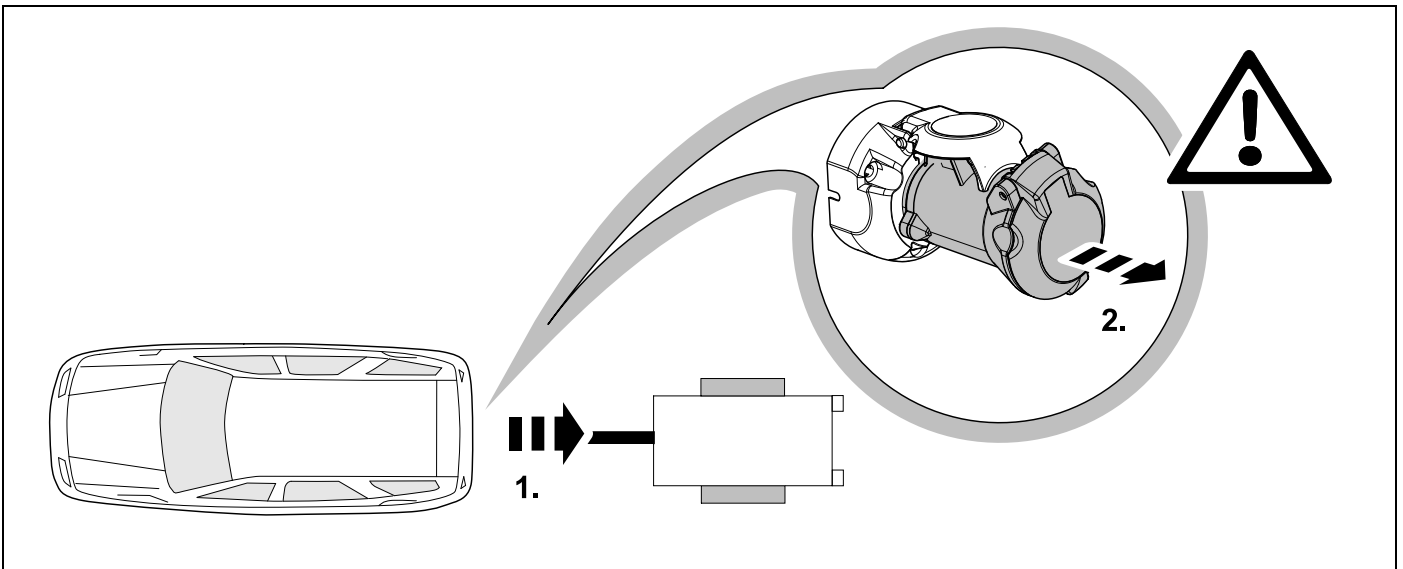

**33**

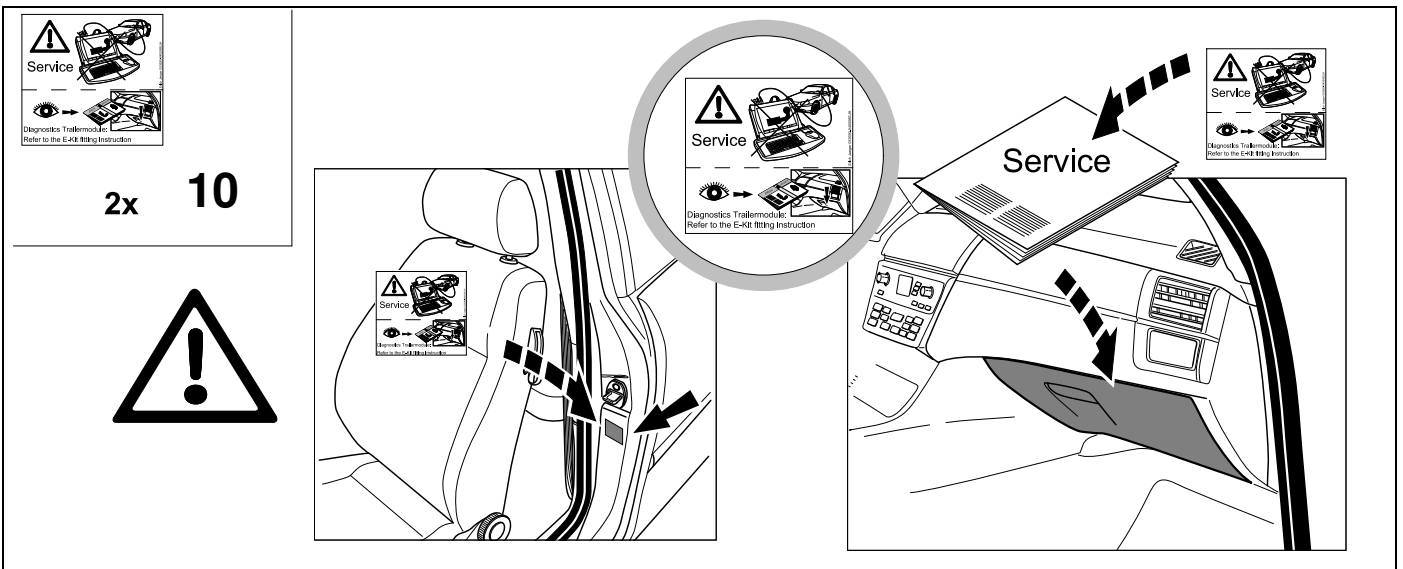

# Status LED für Eigendiagnose

# Status LED for self-diagnosis

## Operation support

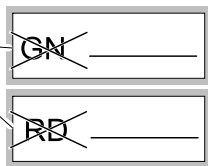
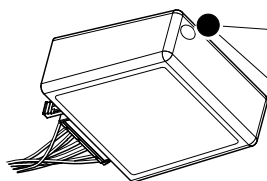
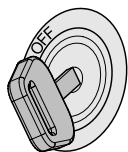

No CAN-Data =



Standby / Sleepmode



Ignition OFF

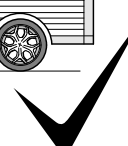
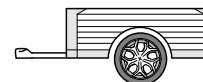
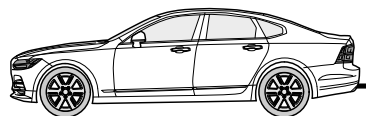
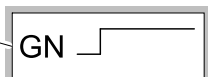
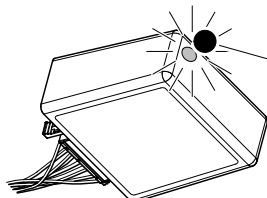

Ignition ON

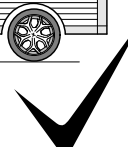
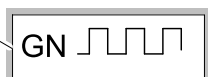
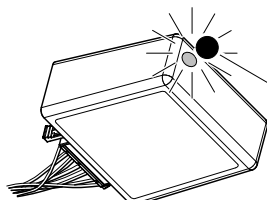
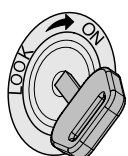

Ignition ON

## Failure support

## Check CAN-Data Wire

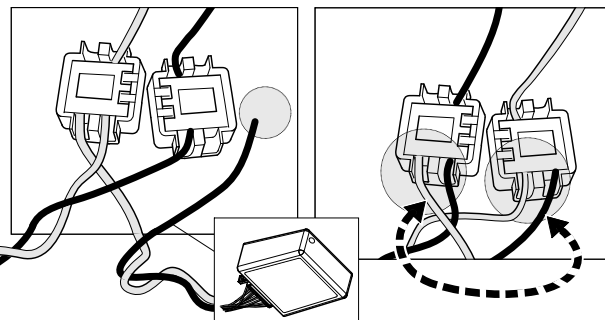
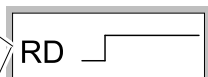
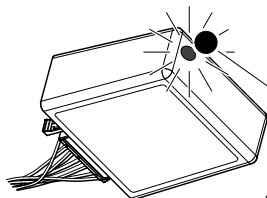
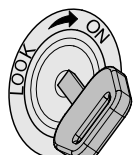

Ignition ON

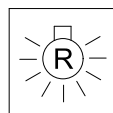
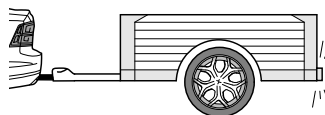

+

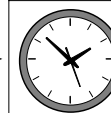
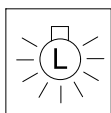

1x max 5 min.

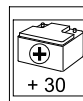
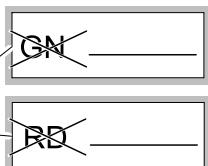
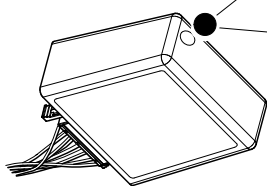

PIN 17

oder / or

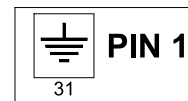

31

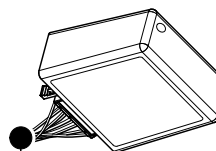
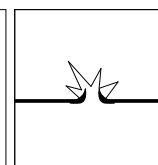
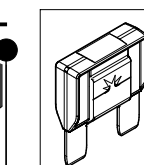
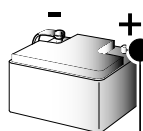

Ignition ON



<p><b>D</b> Änderungen bezüglich Konstruktion, Ausstattung Farbe sowie Irrtum vorbehalten. Angaben und Abbildungen unverbindlich</p>	<p><b>PL</b> Zastrzega się prawo do zmian dot. konstrukcji, wykończenia, kolorystyki oraz pomylek. Dane i ilustracje niewiążące.</p>
<p><b>GB</b> Subject to change in terms of construction, equipment and colour, and may contain errors. The information and illustrations are non-binding.</p>	<p><b>TR</b> Tasarım, donanım ve renk bakımından değişiklik yapma hakkı ve hata ve eksiklik mahfuzdur. Veriler ve resimler bağlayıcı değildir.</p>
<p><b>F</b> Sous réserve de modifications de la construction, de équipement, de la couleur et sous réserve d'erreurs. Les indications et les illustrations sont sans engagement.</p>	<p><b>H</b> A szerkezet, a kivitelt és a szín változtatása, valamint a változások joga fenntartva. Az adatok és az ábrák nem kötelező érvényűek.</p>
<p><b>NL</b> Wijzigingen met betrekking tot constructie, uitvoering en kleur evenals vergissingen voorbehouden. Gegevens en afbeeldingen zyn niet bindend.</p>	<p><b>HR</b> Pravo promjena u svezi konstrukcije, opreme, boje kao i zabune oridžavamo. Podaci i ilustracije su neobavezne.</p>
<p><b>DK</b> Ændringer med hensyn til konstruktion, udstyr, farver samt fejl forbeholdes. Oplysninger og illustrationer er uforpligtende.</p>	<p><b>BUL</b> Запазени права по отношение на конструкцията, оборудването, цвета и грешки. Данните и изображенията не са обвързващи.</p>
<p><b>N</b> Endringer angående konstruksjon, utstyr, farge og feiltagelse forbeholdes. Opplysninger og illustrasjoner uforbindtlig.</p>	<p><b>RO</b> Ne rezervăm dreptul unor modificări ale construcției, dotării, culorii și dreptul la erori Datele indicate și imaginile sunt orientative.</p>
<p><b>S</b> Med reservation för ändringar vad det gäller konstruktion, utrustning, färg samt för misstag. Uppgifterna och bilderna är inte bindande.</p>	<p><b>RU</b> Права на внесение изменений относительно конструкции, оснащения, окраски, а также на ошибки сохраняются. Данные и иллюстрации имеют примерный характер.</p>
<p><b>FIN</b> Pidätämme oikeuden rakennetta, varustusta, väriä koskeviin sekä erehdyksestä johtuviin muutoksiin. Tiedot ja kuvat eivät ole sitovia.</p>	<p><b>LT</b> Pasilieikama konstrukcijos, įrangos bei reikmenų, spalvos pakeitimų ir klaidų teisė. Duomenys ir iliustracijos neįpareigojantys.</p>
<p><b>I</b> Con riserva di modifiche relative a progettazione, dotazione, colore ed errori. Le indicazioni e figure sono fornite senza impegno.</p>	<p><b>LV</b> Tiek paturētas tiesības uz konstrukcijas, iekārtu, krāsu izmaiņām, kā arī kļūdīšanās. Dati un attēli bez saistībām.</p>
<p><b>E</b> Reservadas las modificaciones respecto a diseño, equipamiento, color, así como error. Indicaciones y figuras sin compromiso.</p>	<p><b>EST</b> Konstruktsiooni, varustuse ja võervi osas muudatused ning eksimine lubatud. Andmed ja joonised on mittesiduvad.</p>
<p><b>P</b> Reservamos o direito de alterações relativamente ao desenho, equipamento, cor, bem como de erro. Os dados e as gravuras não implicam compromisso da nossa parte.</p>	<p><b>SLO</b> Zadržana pravica do sprememb glede konstrukcije, opreme, barve ter pomote. Podatki in slike so neobvezne.</p>
<p><b>GR</b> Διατηρώνουμε κάθε επιφύλαξη ως προς αλλαγές σε σχέση με κατασκευή, εξοπλισμό, διαρρυθμίση, χρωματισμούς και λάθη παραδρομής.</p>	<p><b>SK</b> Zmeny, ktoré sa týkajú konštrukcie, vybavenia, farby, ako aj omyly sú vyhradené. Údaje a zobrazenia sú nezáväzné.</p>
<p><b>CZ</b> Změny, týkající se konstrukce, vybavení, barvy, jakož i omyly jsou vyhrazeny. Údaje a vyobrazení jsou nezáväzné.</p>	