

Wiringkit



- D Einbauanleitung
- GB Installation instructions
- F Consignes de montage
- NL Montagehandleiding
- DK Montagevejledning
- N Monteringsinstruksjon
- S Installationsanvisning
- FIN Asennusohje
- I Istruzioni per il montaggio
- E Instrucciones de montaje
- P Instruções de montagem
- GR Οδηγίες εγκατάστασης
- CZ Návod k montáži
- SLO Navodilo za vgradnjo
- SK Montážny návod
- PL Instrukcja montażu
- TR Montaj talimatı
- H Beépítési útmutató
- HR Upute o ugradnji
- BUL Инструкция за монтаж
- RO Instrucțiuni de montaj
- RU Инструкция по монтажу и установке
- LT Montavimo informacija
- LV Iemontēšanas pamācība
- EST Paigaldusjuhend

727803

MERCEDES BENZ

- EQA 03/21 >>
- EQB 11/21 >>

LHD + RHD

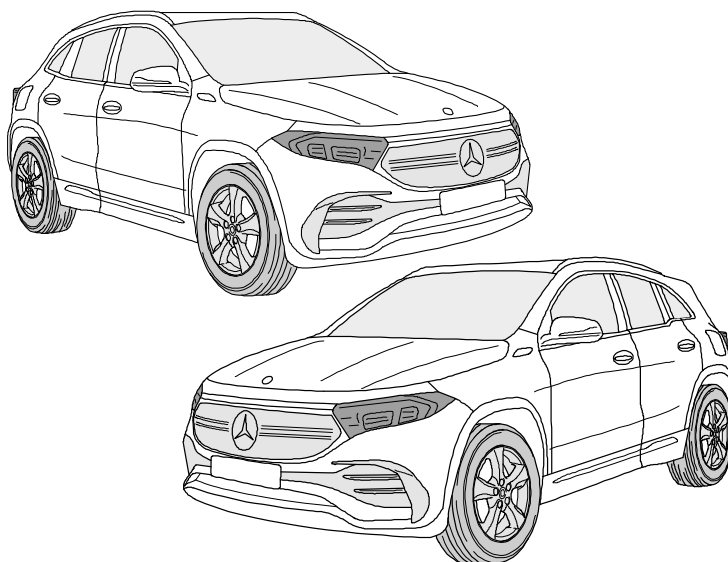
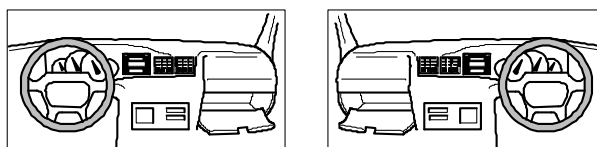

This Fitting Instruction is dated **11-08-2023**.
Always scan for the latest and most complete fitting instructions.



Your perfect fit
brink.eu

BRINK[®]

OVERVIEW

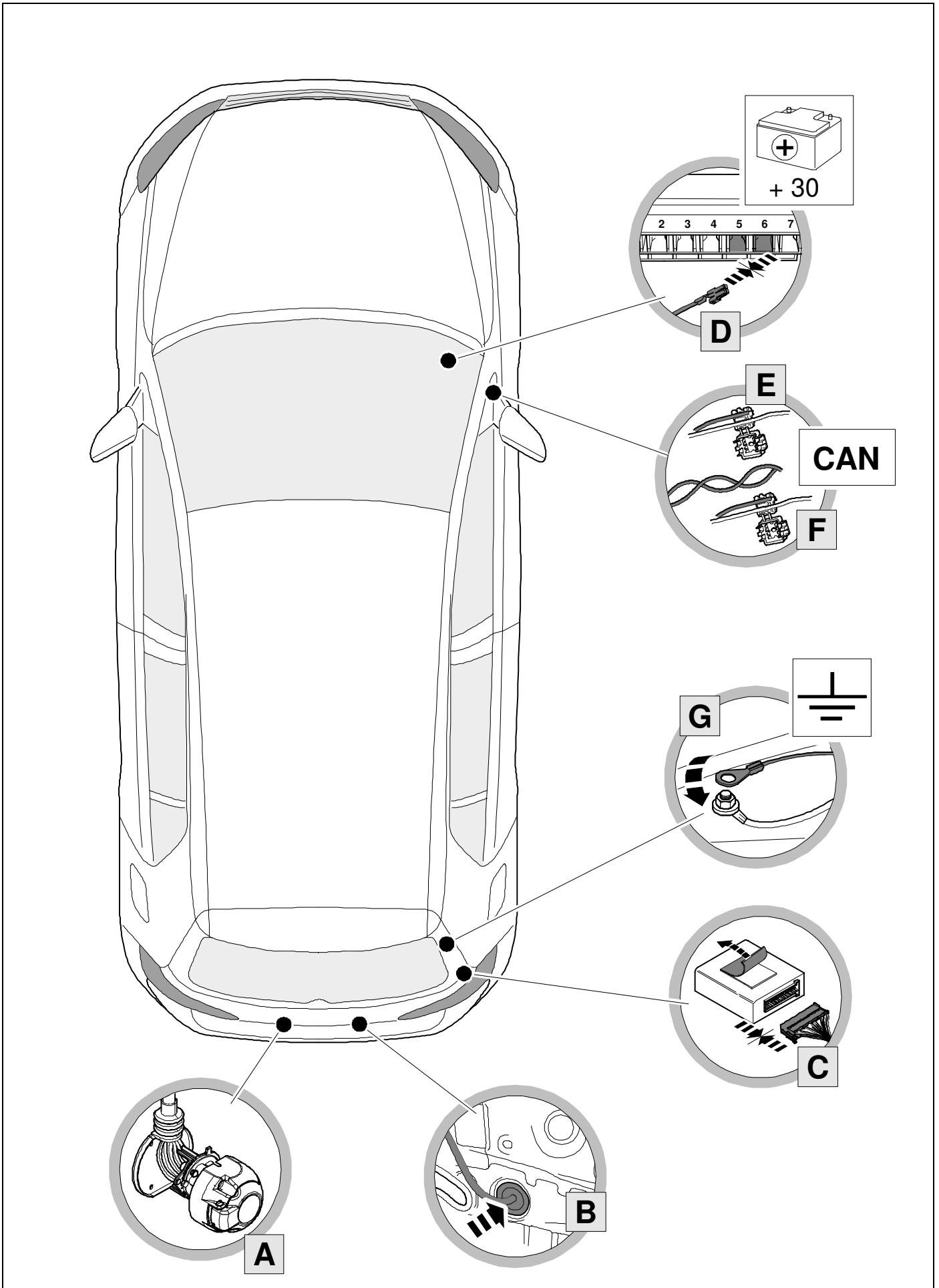

KIT

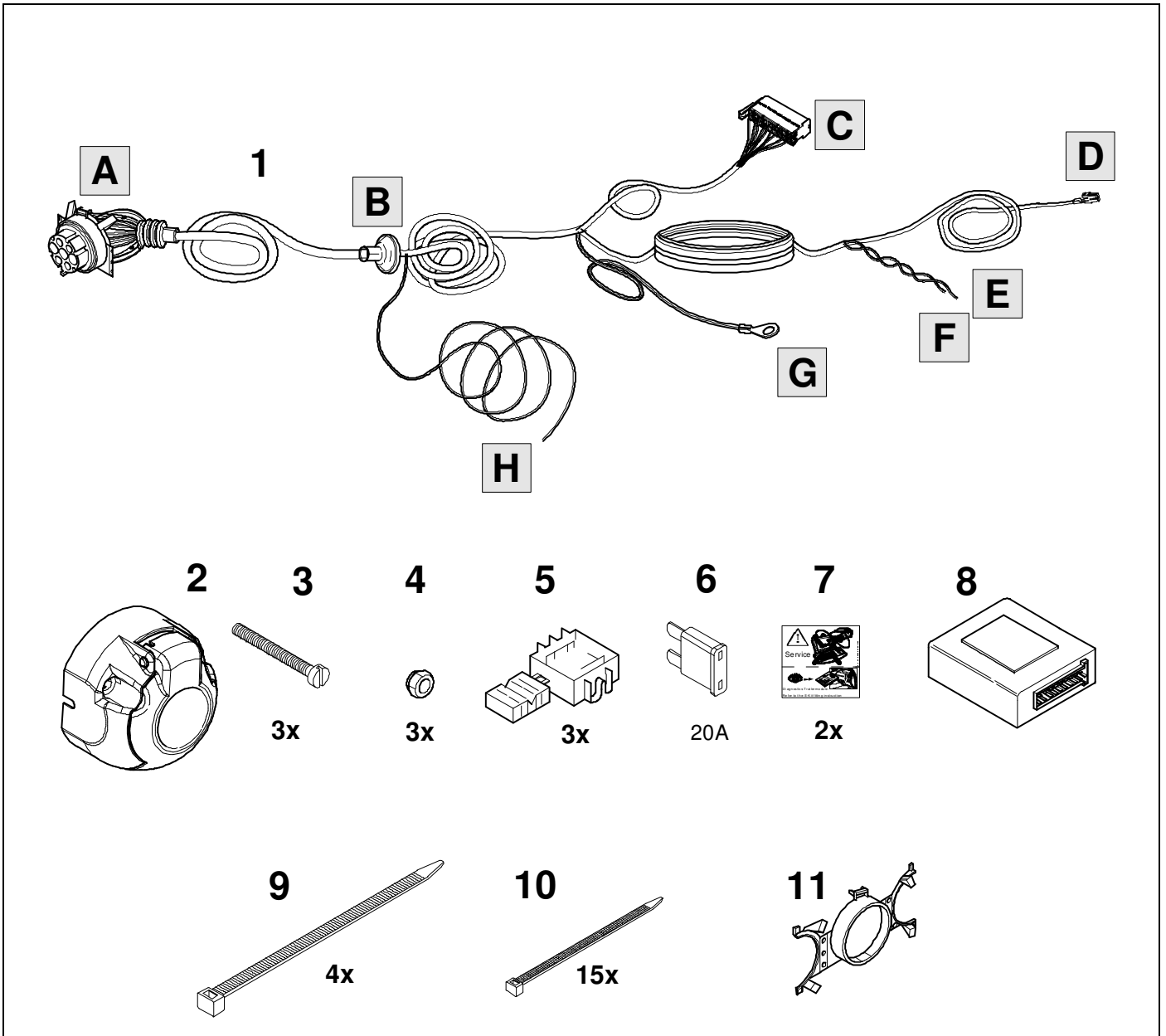

TOOLS

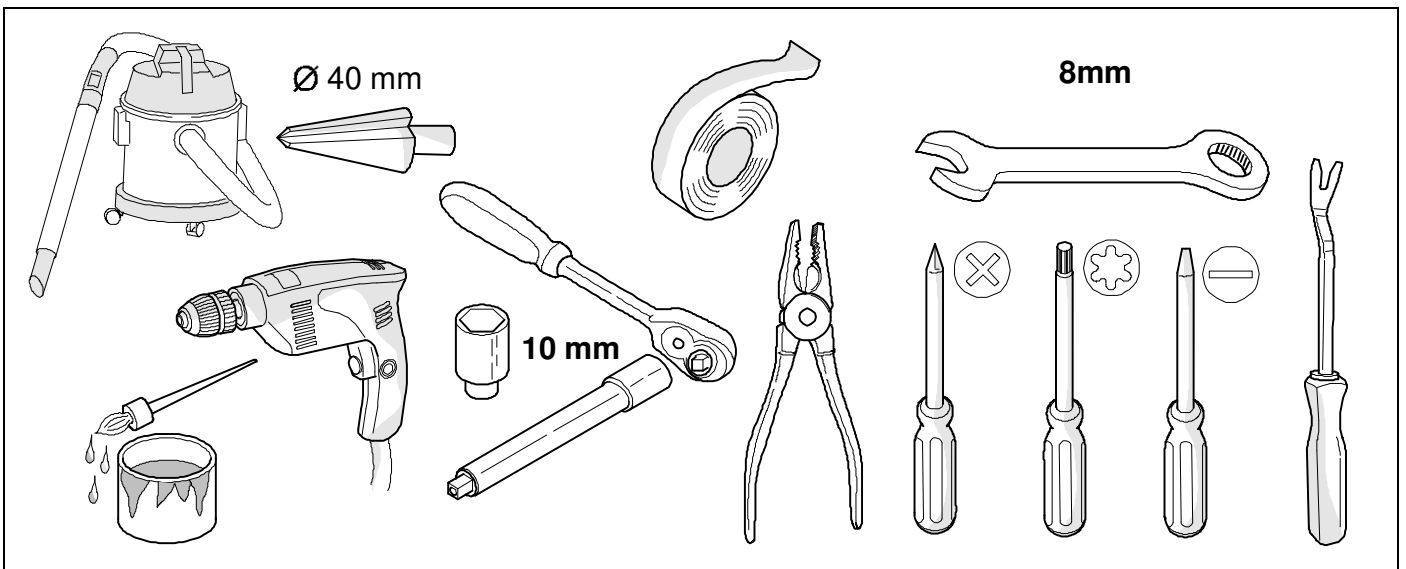

1

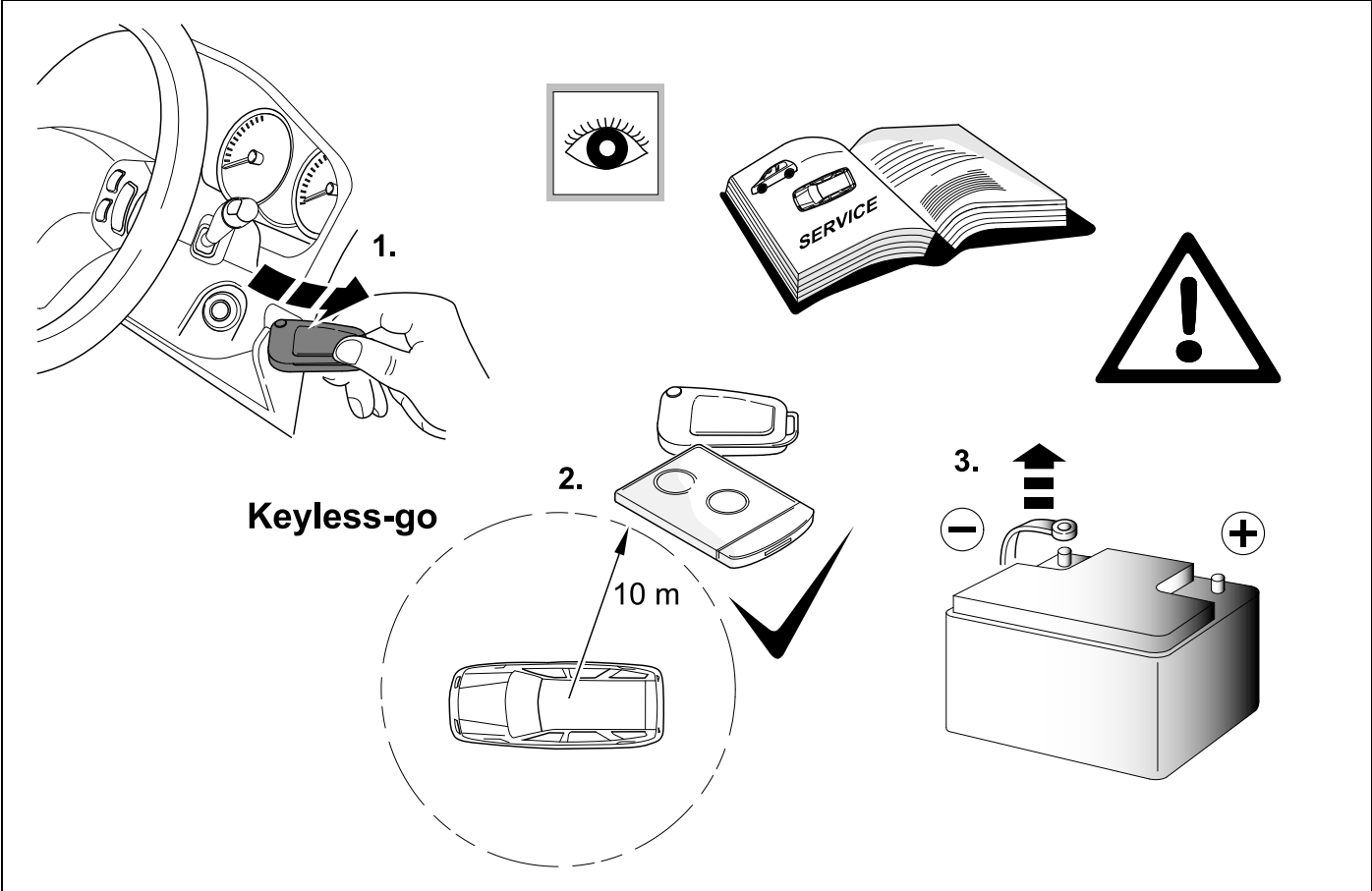

2 REMOVE

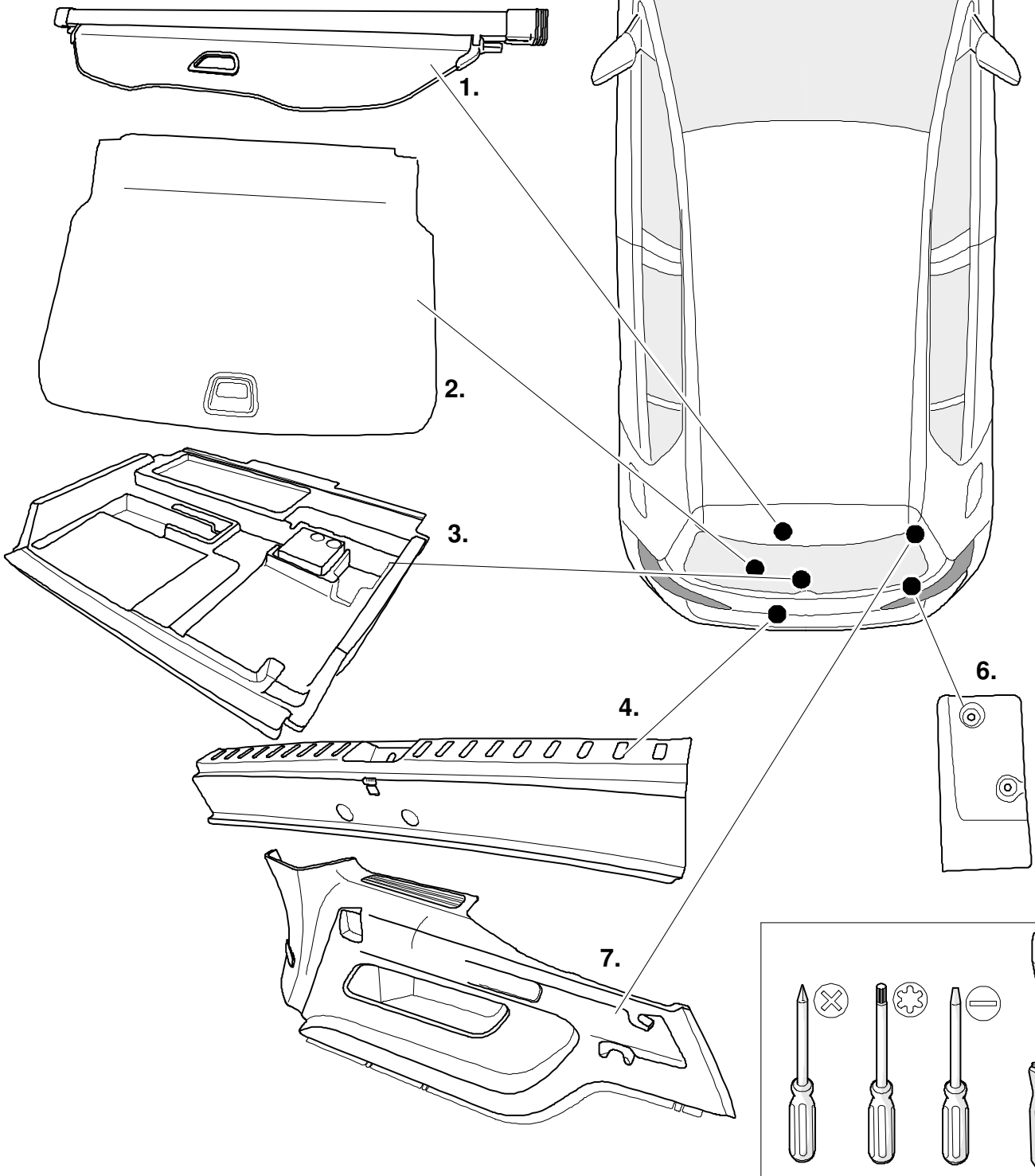
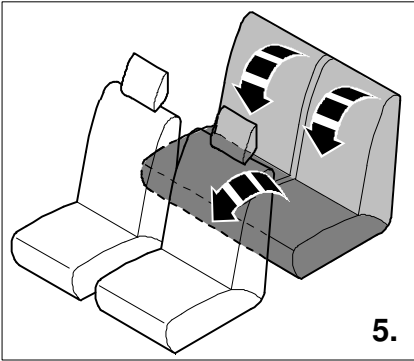

3

OPTION 1

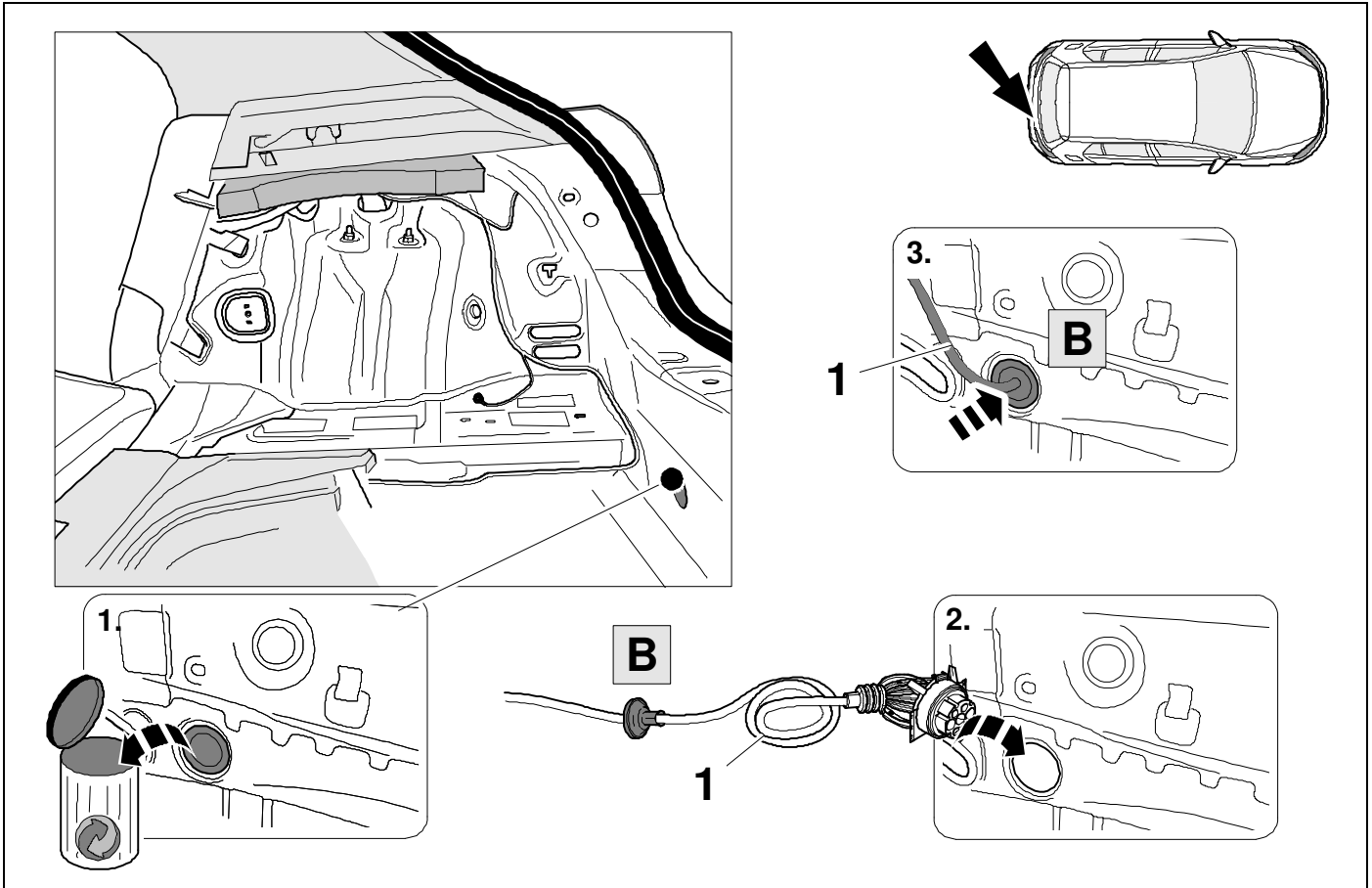

4

OPTION 2

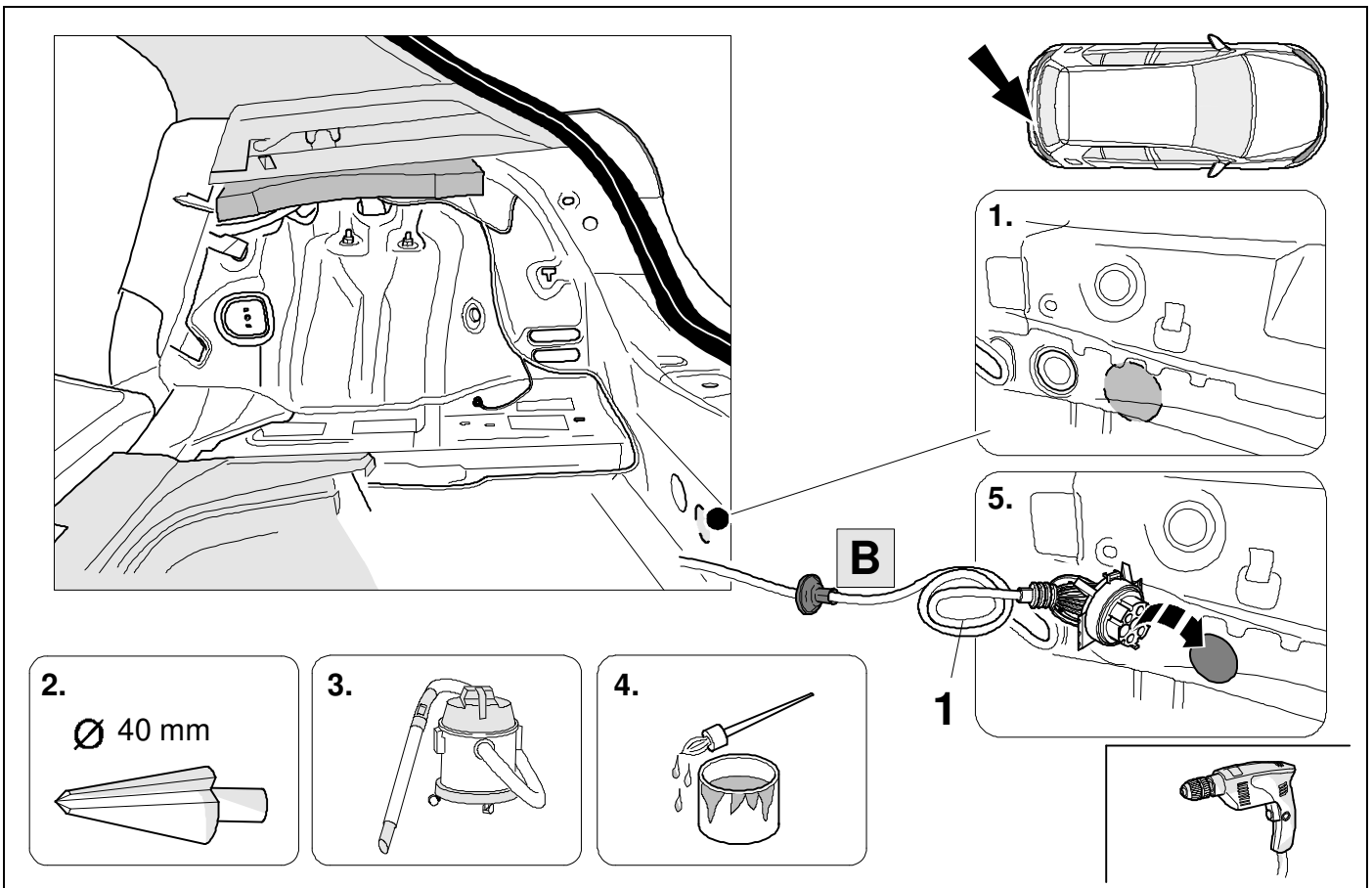

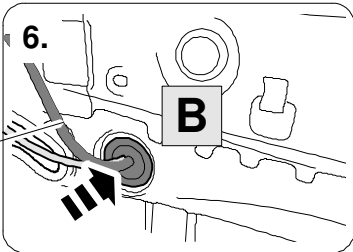
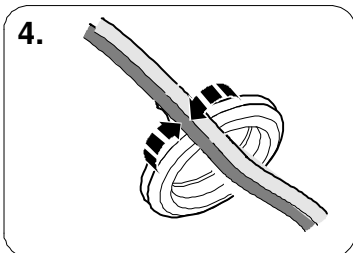
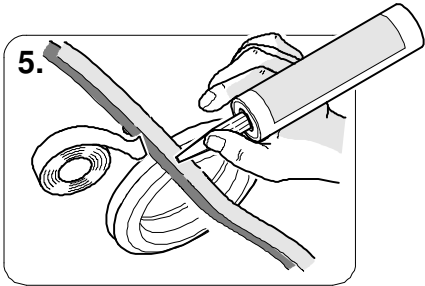
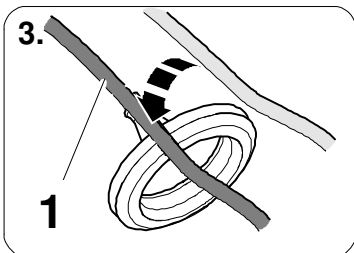
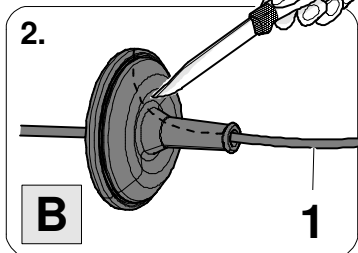
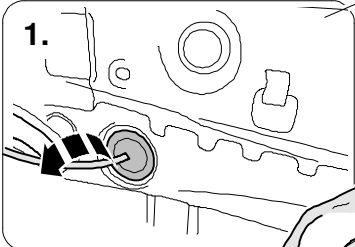
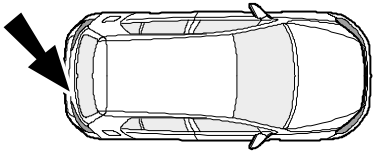
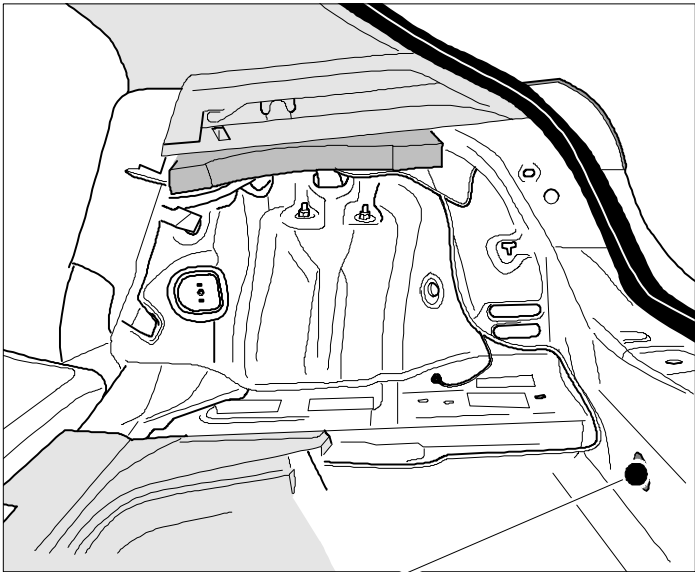

1

6.

1.

2.

3.

5.

4.

B

1

1

B

6

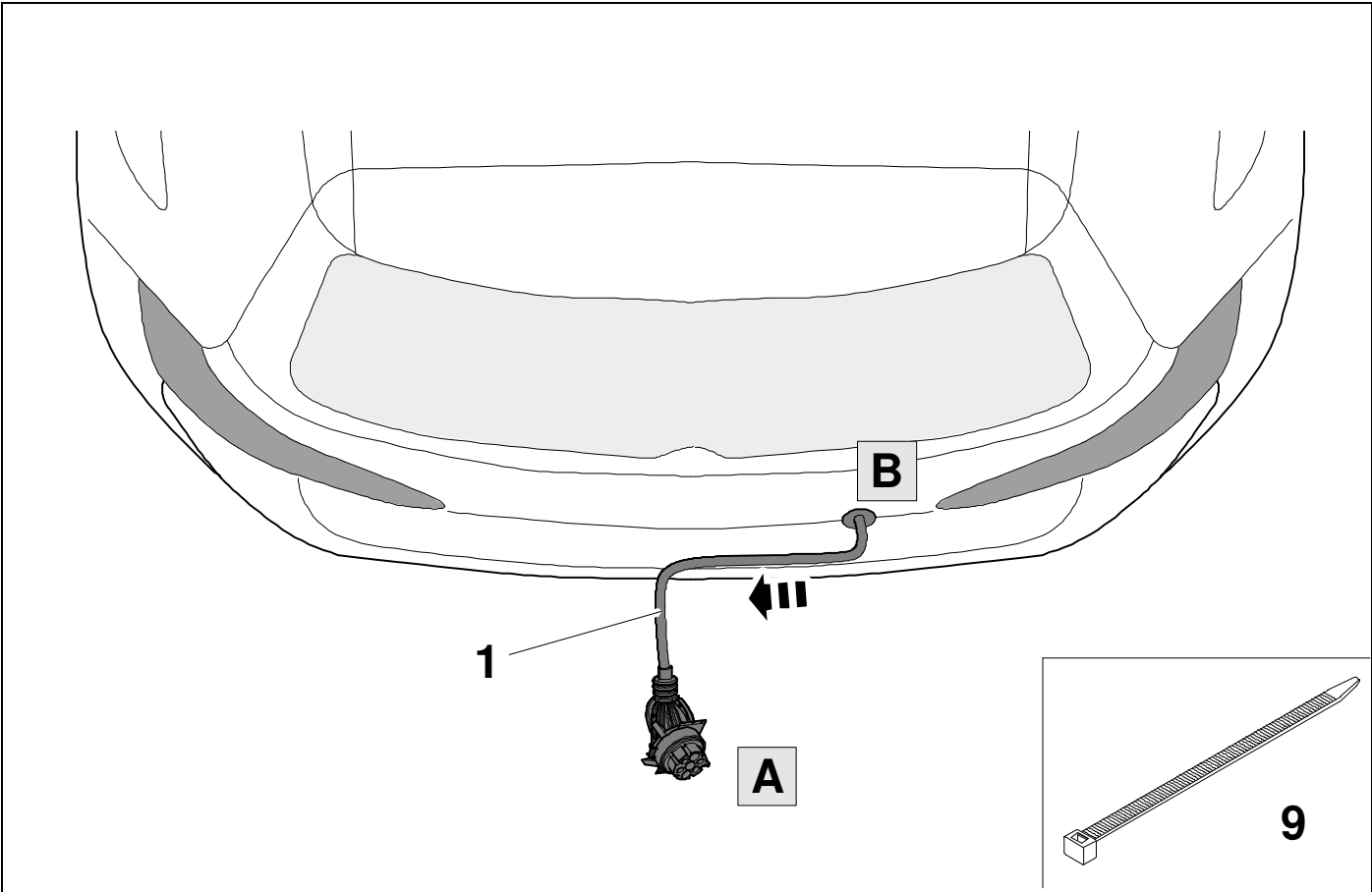

7



8

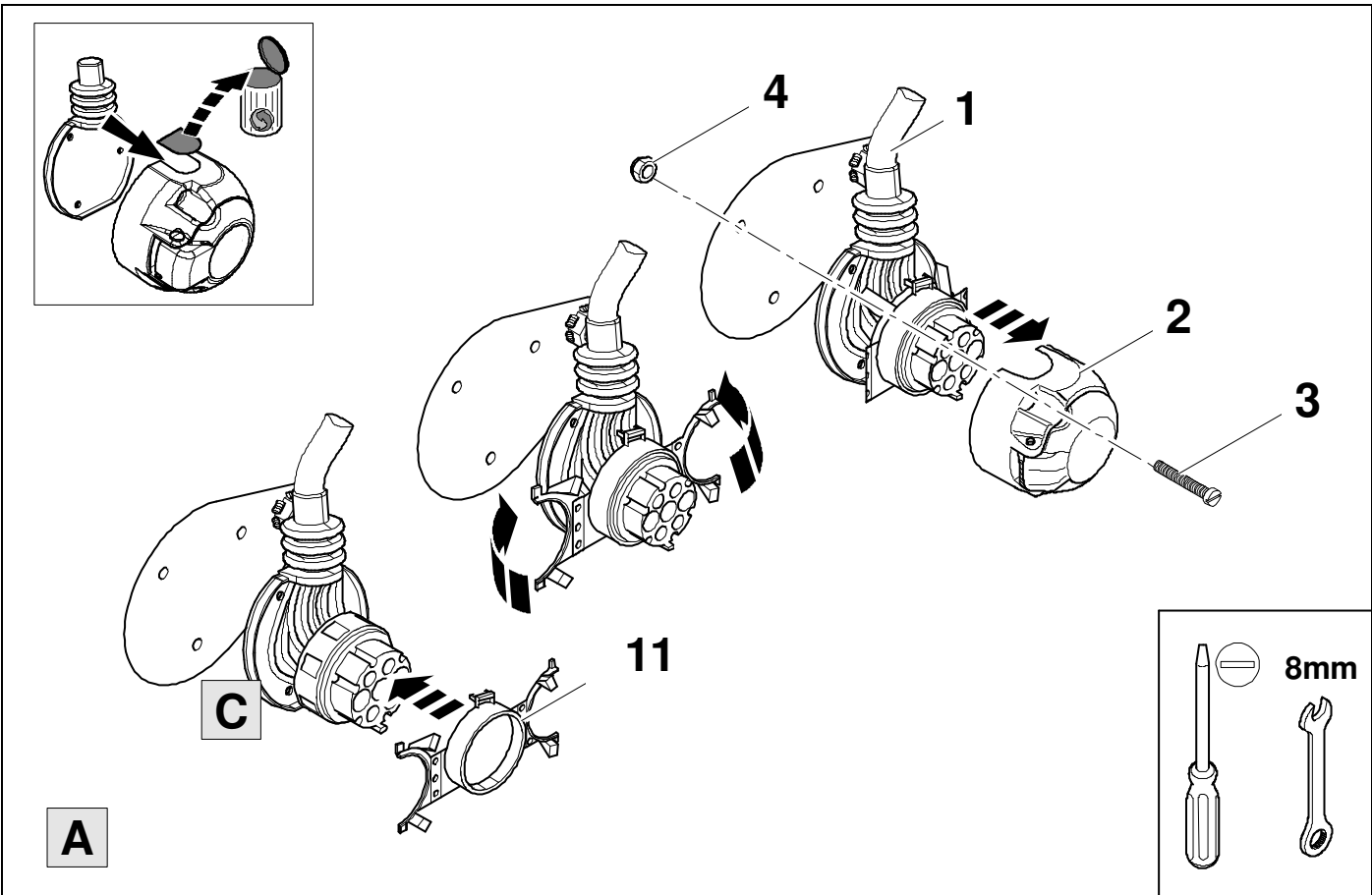



1/L	bk/wh	
2/54g	gy	
3/31	wh/bn	
4/R	bk/gn	
5/58R	gy/rd	
6/54	bk/rd	
7/58L	gy/bk	

9	bk	wh	gy	gn	rd	bu	ye	bn	pu	or	no
(D)	schwarz	weiß	grau	grün	rot	blau	gelb	braun	violett	orange	nicht belegt
(GB)	black	white	grey	green	red	blue	yellow	brown	purple	orange	not occupied
(F)	noir	blanc	gris	vert	rouge	bleu	jaune	brun	violet	orange	inutilisé
(NL)	zwart	wit	grijs	groen	rood	blauw	geel	bruin	violet	oranje	niet aangesloten
(DK)	sort	hvid	grå	grøn	rød	blå	gul	brun	violet	orange	ikke anvendt
(N)	svart	hvit	grå	grønn	rød	blå	gul	brun	fiolett	oransje	ikke i bruk
(S)	svart	vit	grå	grön	röd	blå	gul	brun	violett	orange	ej använd
(FIN)	musta	valkoinen	harmaa	vihreä	punainen	sininen	keltainen	ruskea	violetti	oranssi	ei varattu
(I)	nero	bianco	grigio	verde	rosso	blu	giallo	marrone	viola	arancione	libero
(E)	negro	blanco	gris	verde	rojo	azul	amarillo	marrón	violeta	anaranja-do	no ocupado
(P)	preto	branco	cinzento	verde	vermelho	azul	amarelo	castanho	violeta	laranja	não ocupado
(GR)	μαύρος	λευκός	Γκρι	πράσινος	κόκκινος	μπλε	κίτρινος	καφέ	Μωβ	πορτοκαλί	δεν είναι κοτ ειλημμένος
(PL)	czarny	biały	szaro	zielony	czerwony	niebiesko	żółty	brazowy	fioletowy	pomarańczowy	wolny
(CZ)	černý	bílý	šedý	zelený	červený	modrý	žlutý	hnědý	fialový	oranžový	neobsazen
(TR)	siyah	beyaz	gri	yeşil	kırmızı	mavi	sarı	kahverengi	mor	portakal rengi	boş
(H)	fekete	fehér	szürke	zöld	piros	kék	sárga	barna	ibolyakék	narancssárga	nem foglalt
(HR)	crno	bijelo	sivo	zeleno	crveno	plavo	zuto	smeđe	ljubičasto	narandasto	nije zauzeto
(BUL)	черен	бял	сив	зелен	червен	син	жълт	кафяв	виолетов	оранжев	свободно
(RO)	negru	alb	gri	verde	roșu	albastru	galben	maro	violet	portocaliu	liber
(RU)	черный	белый	серый	зеленый	красный	голубой	желтый	коричневый	пурпурный	оранжевый	свободно
(LT)	juoda	balta	pilka	žalia	raudona	mėlyna	geltona	ruda	purpurinė	oranžinė	laisva
(LV)	melna	balta	pelēka	zaļa	sarkana	zila	dzeltena	brūna	purpur-sarkana	oranža	brīvs
(EST)	must	valge	hall	roheline	punane	sinine	kollane	pruun	purpur-punane	oraanz	vaba
(SLO)	črna	bela	siva	zelena	rdeča	modra	rumena	smeđ	vijoličast	oranžen	ni zasedeno
(SK)	čierny	biely	šedý	zelený	červený	modrý	žltý	hnědý	fialový	pomaraňový	neobsadený

10



9

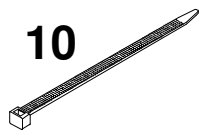
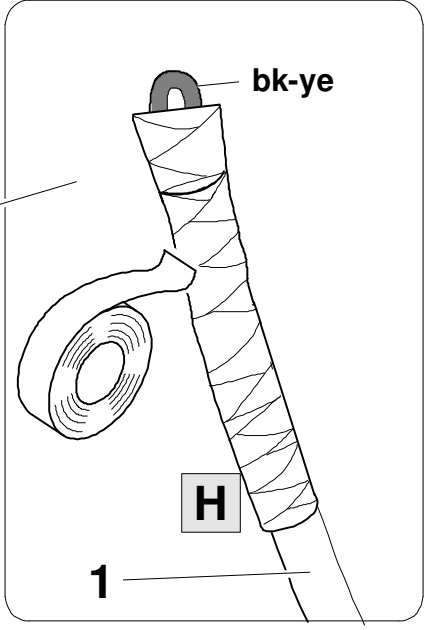
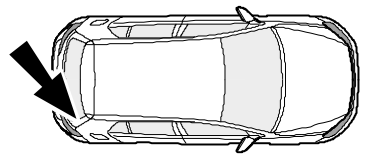
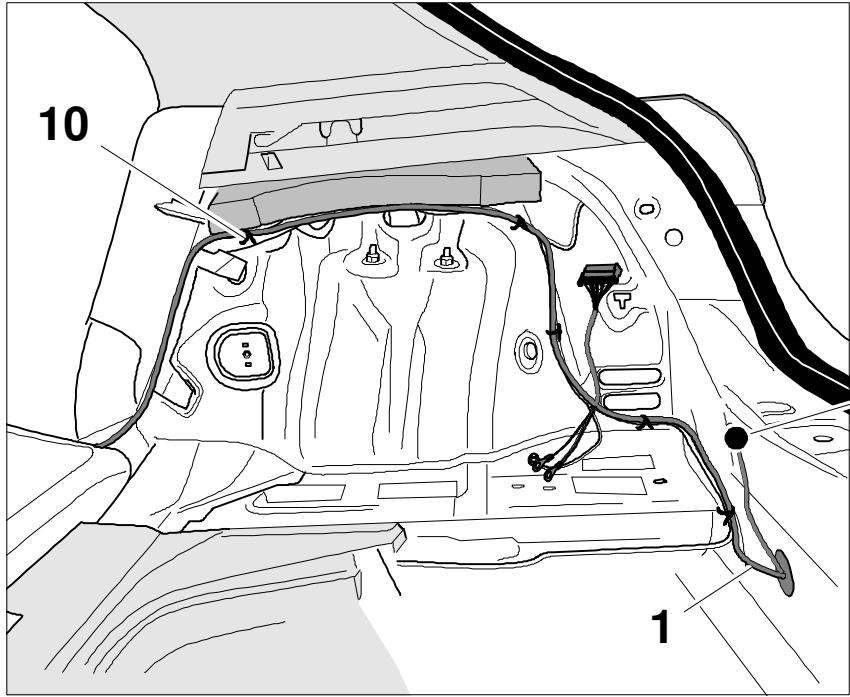

11

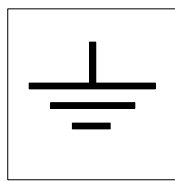
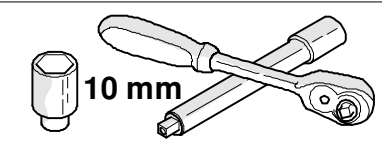
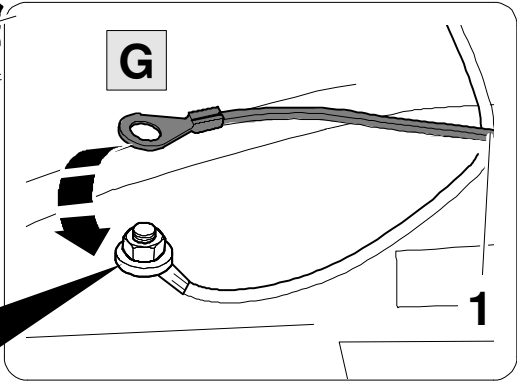
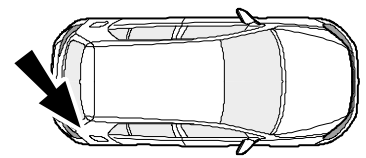
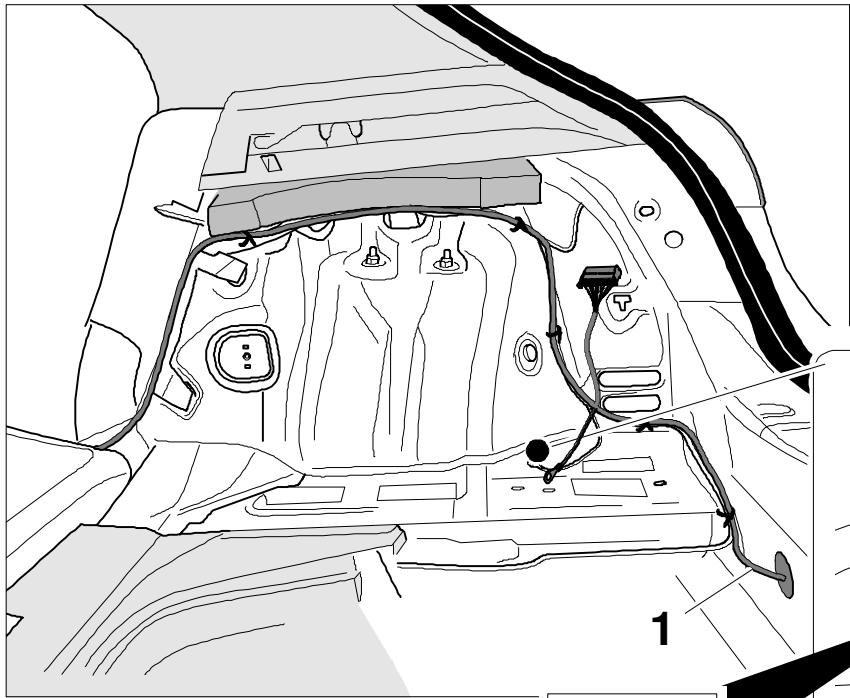

12

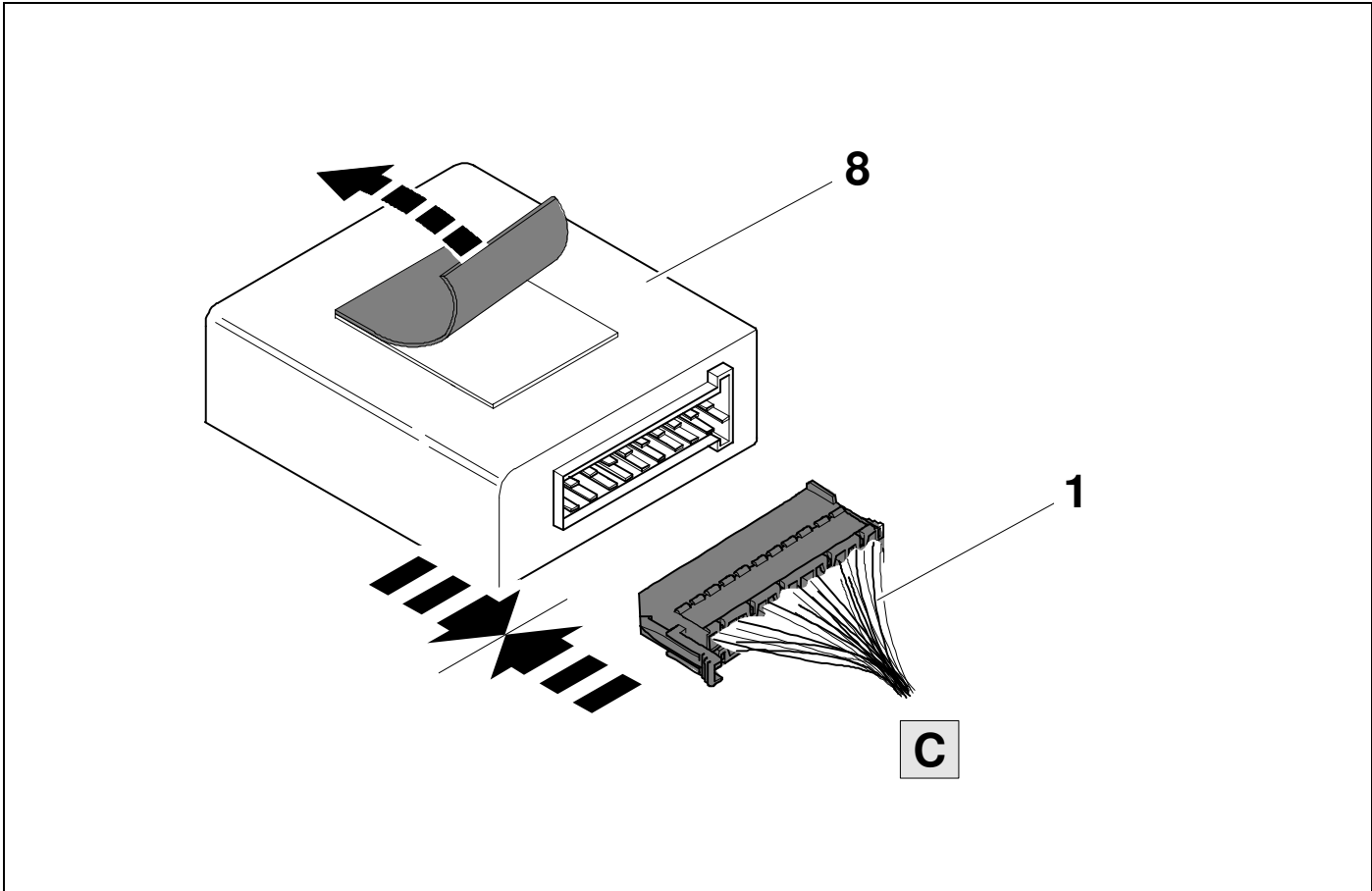

13

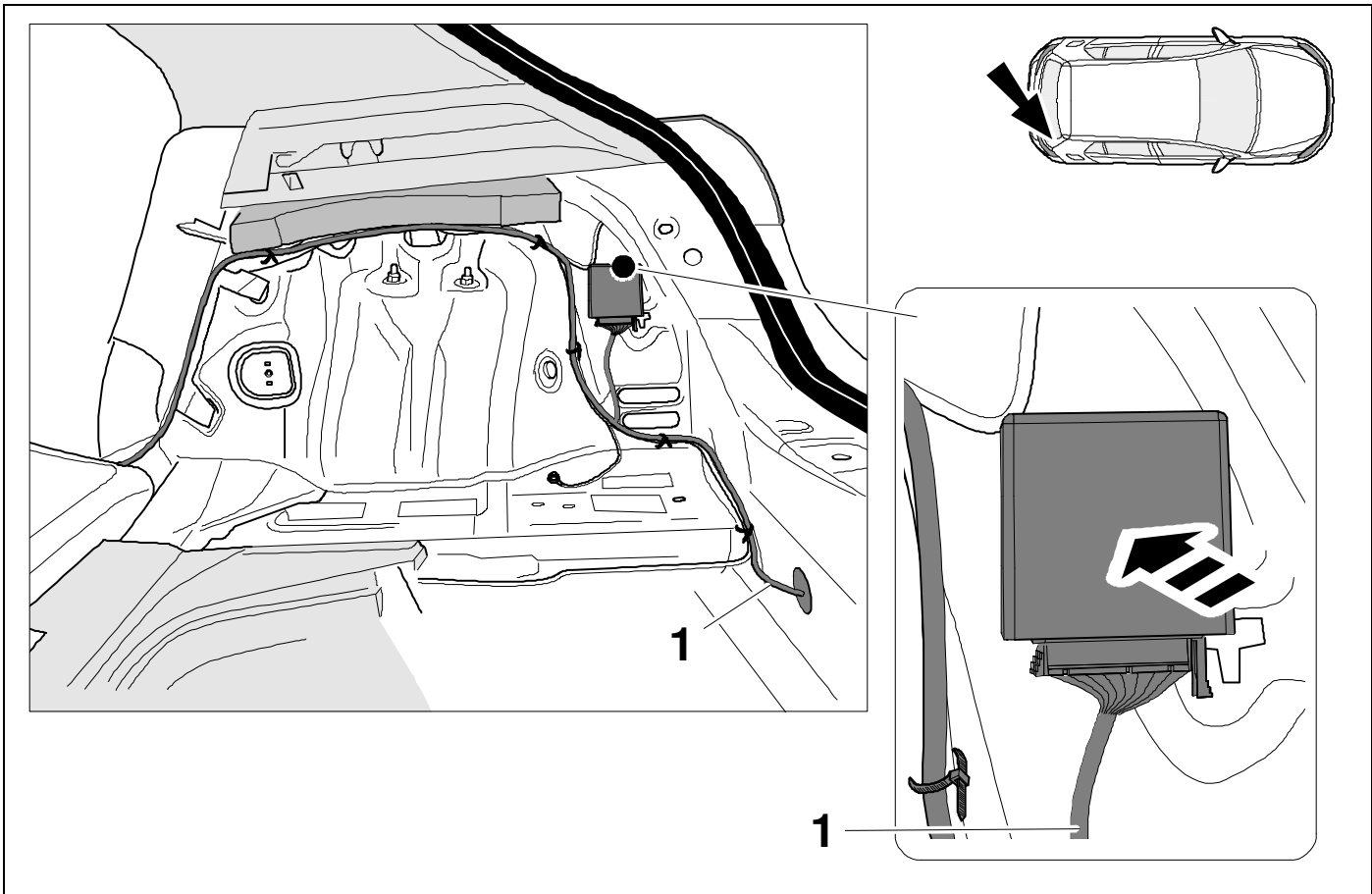

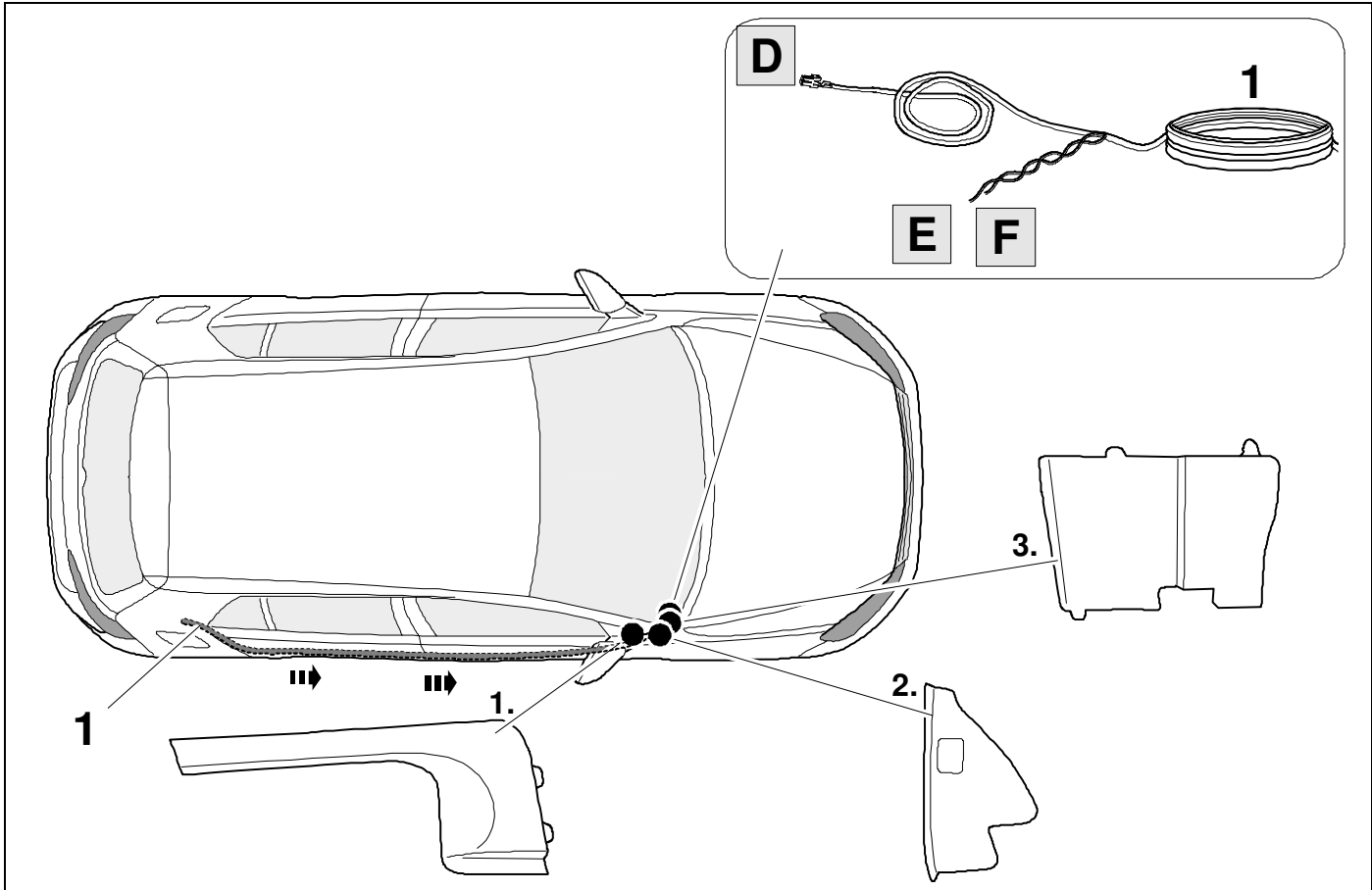

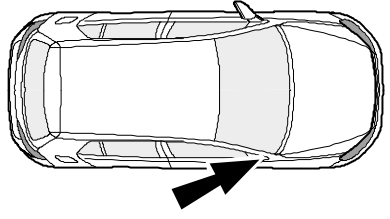
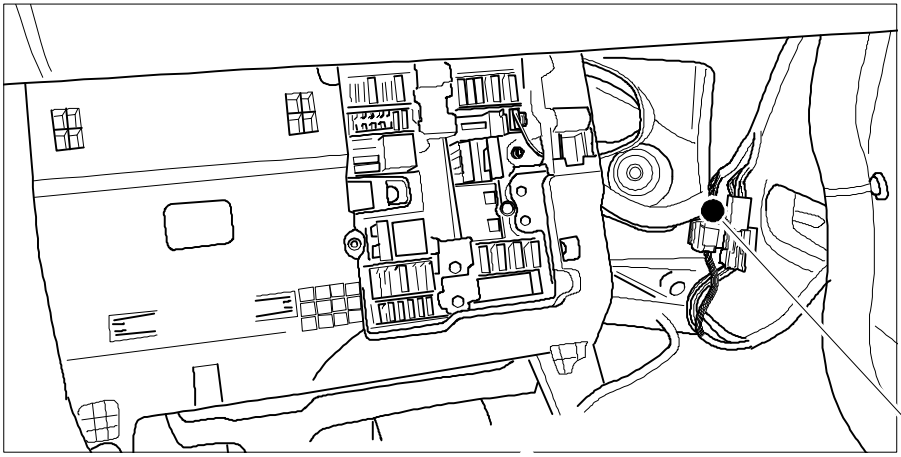

CAN

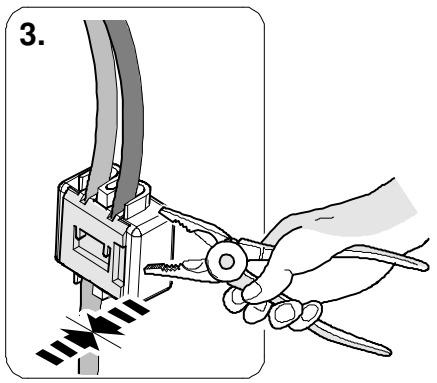
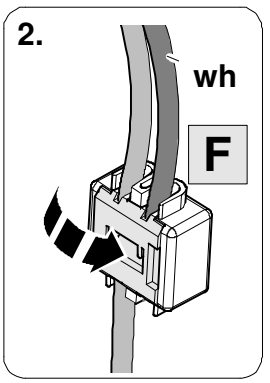
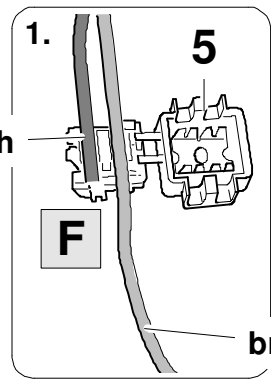
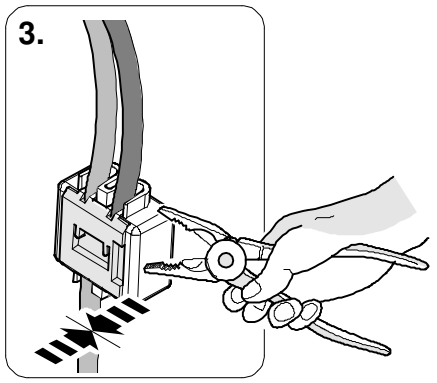
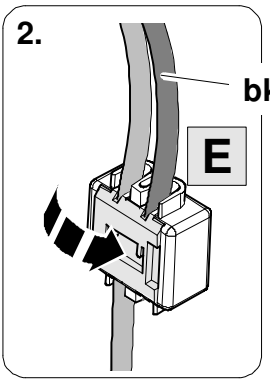
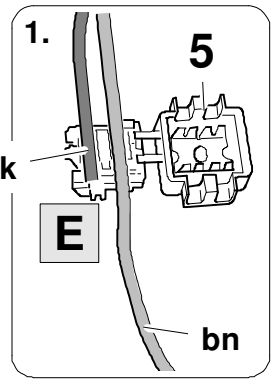
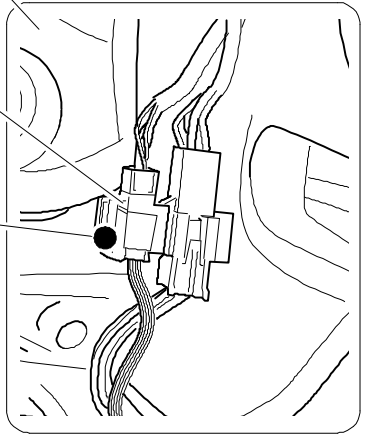
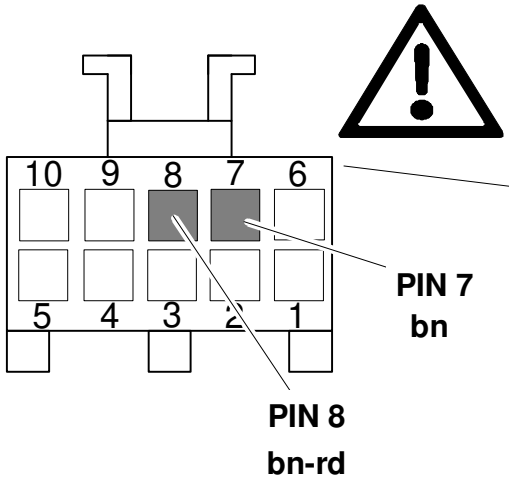



1.

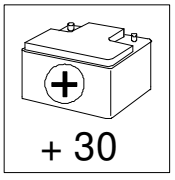
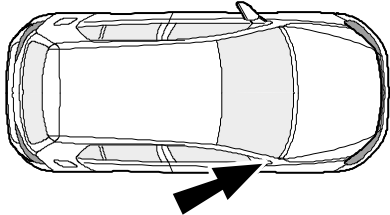
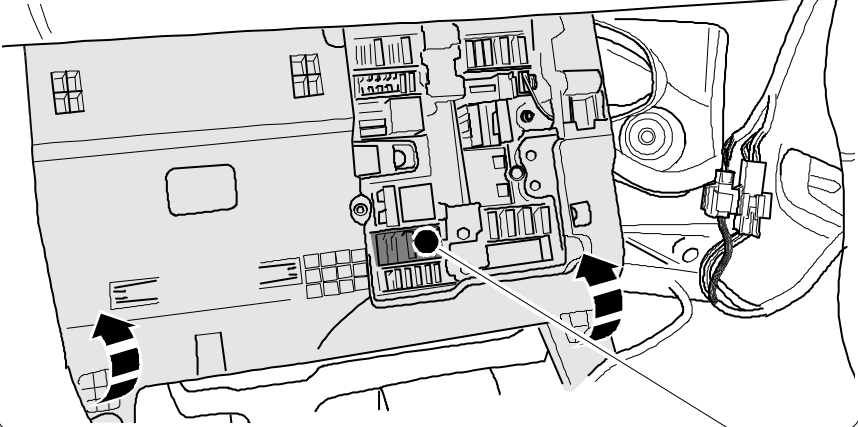

2.

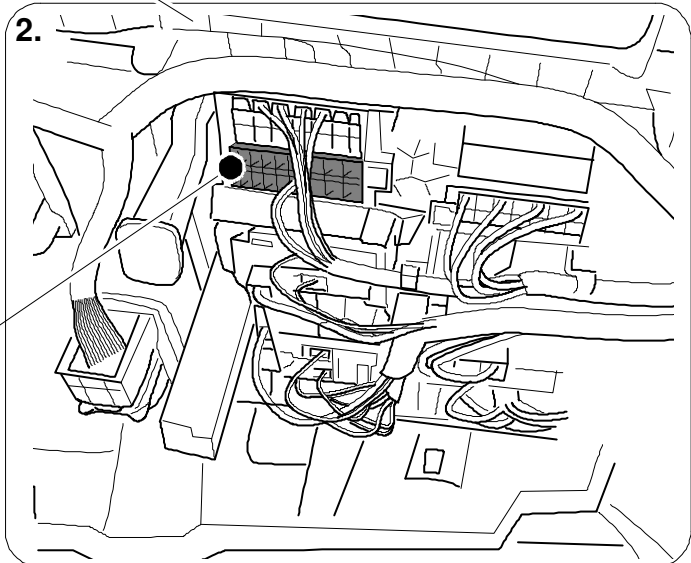

3.

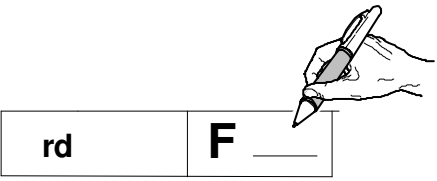
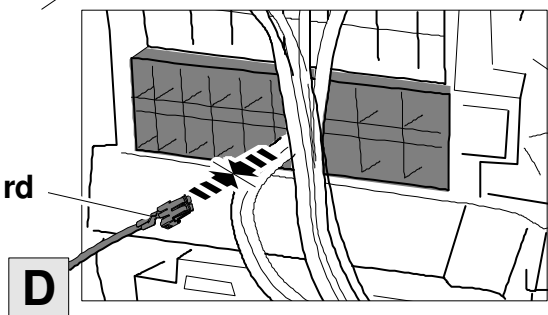

4.

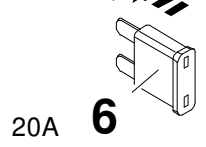
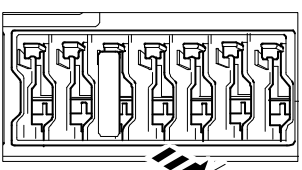

17

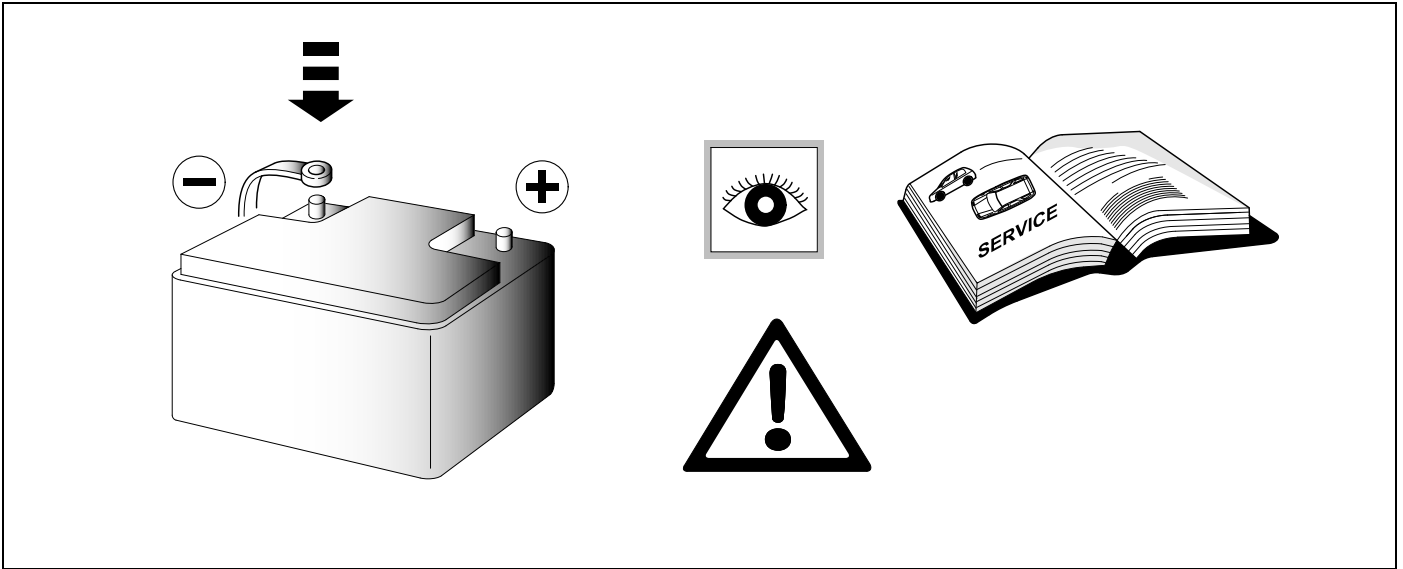

18 JIFELINE CODING

OPTION 1



Need help programming this wiringkit?

If possible, we provide tips in our manuals on how the vehicle can be coded. It is always possible that more or different coding steps are required for your specific vehicle. That is why we recommend the use of Jifeline.

Jifeline codes your vehicle online with the most up to date knowledge.

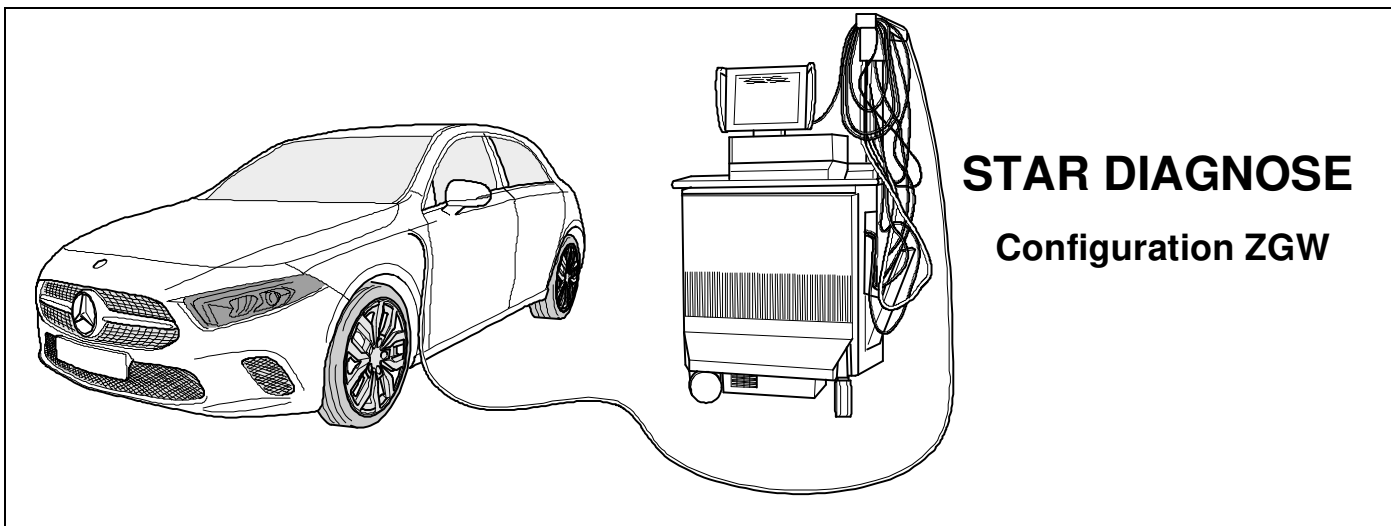

STAR DIAGNOSE

Configuration ZGW

Allgemein

(D)

Nach Einbau des E-Satzes ist die obligatorische Anhängerbeleuchtung sowie die in einigen Ländern gesetzlich vorgeschriebene Anhängerblinküberwachung ohne jede Freischaltung am Fahrzeug gewährleistet! Ein Defekt eines Fahrtrichtungsanzeigers am Anhänger wird den Fahrer über das Informationsdisplay im Kombi-Instrument angezeigt!

HINWEIS:

Sollte sich die Fahrzeug seitige Nebelschlussleuchte nicht automatisch im Anhängerbetrieb abschalten, muss die Zentralelektrik wie folgt codiert werden:

Fahrzeuge mit Einparkhilfe

Die automatische Deaktivierung der rückwärtigen Einparkhilfe im Anhängerbetrieb wird durch nachfolgende Codierung via Diagnose-Assistenz-System erreicht:

- Steuergeräte
- Aufbau
- ZGW - Zentrales Gateway / EZS - Elektronischer Zündstartschalter
- Steuergeräte-Anpassungen
- Codierung lesen und gegebenenfalls ändern
- Anhänger (auf vorhanden schalten!)
- Codierung durchführen (F5)

Nach erfolgter Codierung wird neben der Deaktivierung einer rückwärtigen Einparkhilfe im Anhängerbetrieb auch der Ausfall eines Fahrtrichtungsanzeigers am Anhänger als erweiterte Fehler-Meldung im Informationsdisplay des Kombi-Instruments dargestellt, verbunden mit einer Blinkfrequenzerhöhung der Fahrzeug seitigen Kontrollleuchte für Fahrtrichtungsanzeige!

General

(GB)

After installation of the electrics kit, the Mandatory trailer lighting and the trailer indicator monitoring that is required by law in some countries, operates automatically with no additional software! Any defect in the trailer direction indicators is shown by a bulb failure symbol on the information display on the instrument panel.

NOTE:

If the vehicle's rear fog lamp does not switch off automatically in trailer mode, the following code must be entered into the central electrical system:

Vehicles with parking assistance

Deactivation of the reversing parking sensors when towing a trailer, can be programmed by the dealer using the dealer diagnostic assistance system. This is simply carried out by following the coding procedure below:

- control devices
- construction
- ZGW – central gateway/ EZS - electronic starter
- control device adjustment
- read the coding and change if necessary
- trailer (switch to "present")
- execute coding (F5)

After coding, to deactivate the rear parking sensors, there is an additional warning of trailer indicator failure, by the double flash rate of the direction arrows on the instrument display, and as an extended defect report in the information display section of the instrument panel.

Généralités

(F)

Après le montage d'un kit électrique, l'éclairage obligatoire de la remorque ainsi que la surveillance – prescrite dans certains pays – des indicateurs de direction de la remorque sont assurés sur le véhicule, sans qu'aucune validation ne soit nécessaire! Un défaut de l'indicateur de direction de la remorque est signalé au conducteur sur le panel de contrôle!

AVERTISSEMENT:

Si le feu brouillard arrière monté sur le véhicule ne s'éteint pas automatiquement, il faut compléter la configuration en codant l'électricité centrale comme suit:

Véhicules avec aide au parking

La désactivation automatique de l'aide au parking monté à l'arrière, lors de l'utilisation d'une remorque est obtenue par le codage suivant sur le système d'assistance et de diagnostic:

- systèmes de commande
- structure h
- ZGW - Gateway central/ EZS - clé de contact électronique
- paramétrage des systèmes de commande lire et modifier éventuellement le codage
- remorque (basculer sur présente!)
- exécuter le codage (F5).

Lorsque le codage est effectué, outre la désactivation de l'aide au parking monté à l'arrière, en présence d'une remorque, la panne d'un indicateur de direction de la remorque est présentée comme un message d'erreur étendu sur l'affichage d'information de l'instrument combiné, associée à une augmentation de la fréquence de clignotement des voyants de contrôle des indicateurs de direction, côté conducteur!

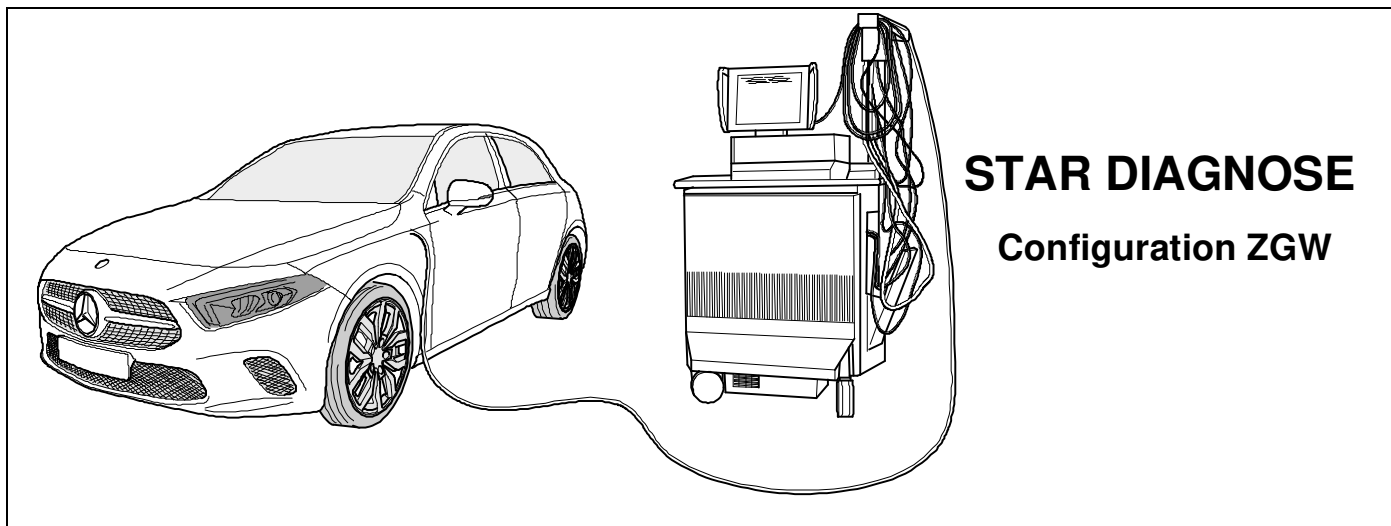

STAR DIAGNOSE

Configuration ZGW

Informazioni generali

(I)

Dopo l'installazione del kit elettrico l'illuminazione obbligatoria del rimorchio ed il controllo dei lampeggianti del rimorchio (obbligatorio in alcuni paesi) sono garantiti senza alcuna attivazione! Il guasto di un indicatore di direzione del rimorchio è segnalato al guidatore attraverso il display informativo nel pannello di controllo!

AVVERTENZA:

Se il retronebbia del veicolo non dovesse spegnersi automaticamente, è necessario codificare l'impianto elettrico centrale come segue:

Veicoli con sensori di parcheggio

La disattivazione automatica dei sensori di parcheggio posteriori in presenza di un rimorchio è ottenuta tramite la seguente codificazione con il sistema di assistenza alla diagnosi:

- Sistemi di controllo
- Organizzazione
- ZGW – Gateway centrale/
EVS - Interruttore d'avviamento elettronico
- Modifiche ai sistemi di controllo
- Leggere la codifica e modificare se è il caso
- rimorchio (commutare su presente!)
- Eseguire la codifica (F5)

Dopo avere completata la codifica, oltre alla disattivazione dei sensori di parcheggio posteriori quando è presente un rimorchio, il display informativo dello strumento multifunzione indica anche eventuali guasti agli indicatori di direzione del rimorchio, insieme ad un aumento della frequenza di lampeggio delle spie degli indicatori di direzione del veicolo!

Generalidades

(E)

¡Después del montaje del equipo electric queda asegurada la iluminación obligatoria del remolque así como el control de intermitentes del remolque prescritos por la ley en algunos países sin ninguna clase de activación en el vehículo! ¡Un defecto en uno de los intermitentes del remolque se le indicará al conductor en el display de información del instrumento combinado!

NOTA:

En caso de que la luz antiniebla trasera del vehículo no se apague automáticamente, deberá codificarse el sistema eléctrico central adicionalmente a la configuración arriba mencionada del siguiente modo:

Vehículos con ayuda al aparcamiento

La desactivación automática de la ayuda al aparcamiento trasera en el servicio con remolque se consigue con la siguiente codificación del sistema de asistencia de diagnóstico:

- Reguladores
 - Estructura
 - ZGW gateway central / EZS interruptor electrónico de encendido y de arranque
 - Adaptaciones de reguladores
 - Lectura de codificación y modificación en caso necesario
 - Remolque (¡conmutar a presente!)
 - Llevar a cabo la codificación (F5)
- ¡Tras haber realizado la codificación, aparte de la desactivación de una de las ayudas traseras al aparcamiento en el servicio con remolque, también se visualizará un fallo de uno de los intermitentes del remolque en forma de un mensaje de error ampliado en el display de información del instrumento combinado, acompañado de un aumento de la frecuencia de intermitencia en la lámpara de control de intermitentes del vehículo!

Algemeen

(NL)

Na inbouw van de elektroset zijn de verplichte aanhangerverlichting en de in enkele landen wettelijk voorgeschreven knippercontrole van de aanhanger zonder enige vrijschakeling op het voertuig gegarandeerd! Een defect van een richtingaanwijzer op de aanhanger wordt aan de chauffeur aangegeven via het informatiedisplay in het combi-instrument!

AANWIJZING!

Mocht de mistlamp op het voertuig tijdens gebruik van de aanhanger niet automatisch worden uitgeschakeld, dan moet de centrale elektrische installatie als volgt worden gecodeerd:

Voertuigen met inparkeerhulp

De automatische deactivering van de achterwaartse inparkeerhulp tijdens gebruik van de aanhanger wordt bereikt door de volgende codering via het Diagnose-Assistentie-Systeem:

- Regeleenheden
- Opbouw
- CGW - Centrale Gateway / EOS-Elektronische Ontstekingsstartschakelaar
- Aanpassingen regeleenheden
- Codering lezen en indien nodig wijzigen
- Aanhanger (op aanwezig schakelen!)
- Codering uitvoeren (F5)

Nadat de codering is verricht, wordt naast de deactivering van een achterwaartse inparkeerhulp tijdens het gebruik van de aanhanger ook het uitvallen van een richtingaanwijzer op de aanhanger als uitgebreide storingsmelding op het informatiedisplay van het combi-instrument weergegeven, in combinatie met een verhoging van de knipperfrequentie van de controlelamp voor richtingaanwijzing op het voertuig!

21 CHECK

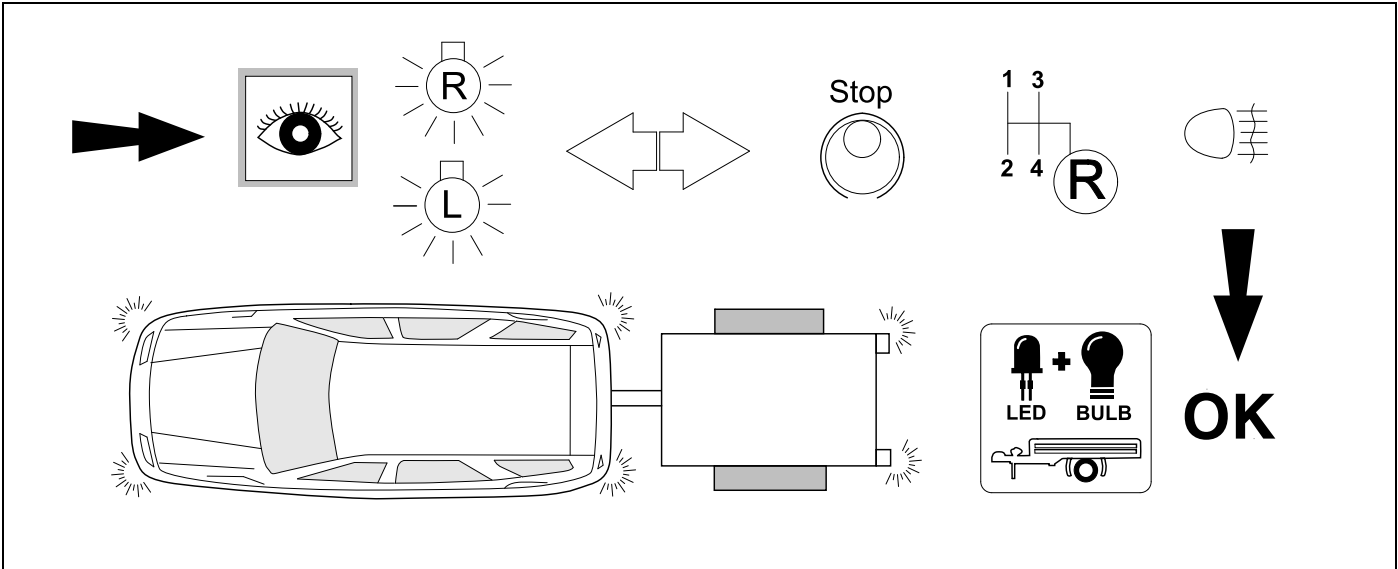

22 OPTIONAL



23 CHECK

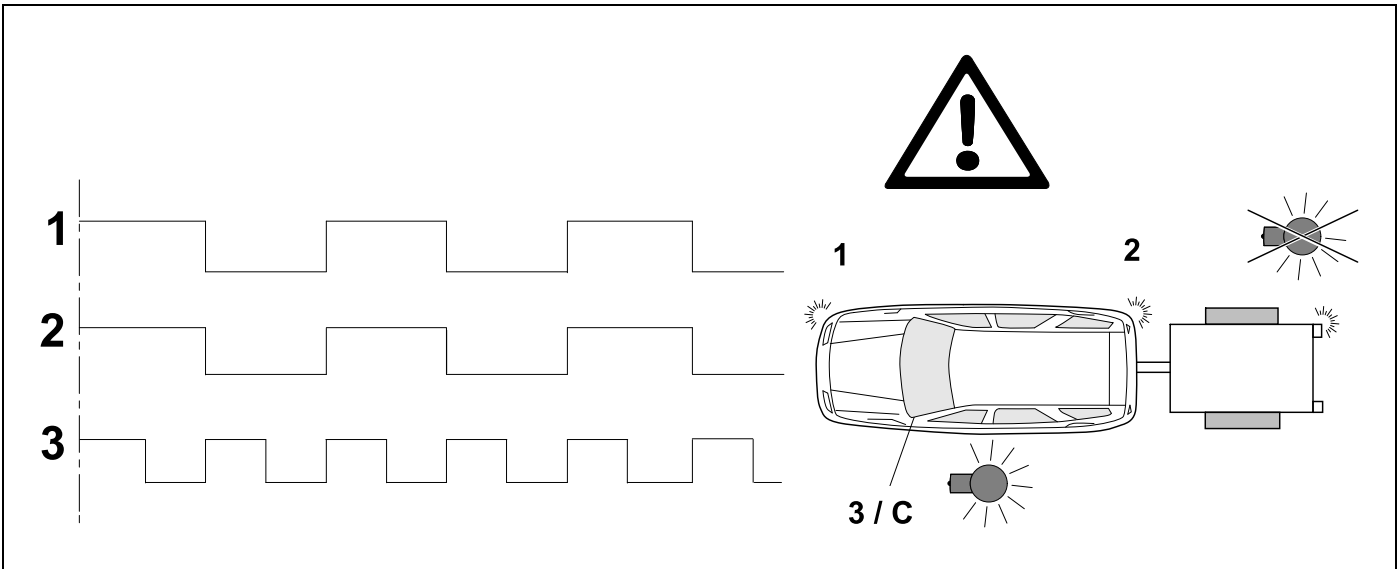

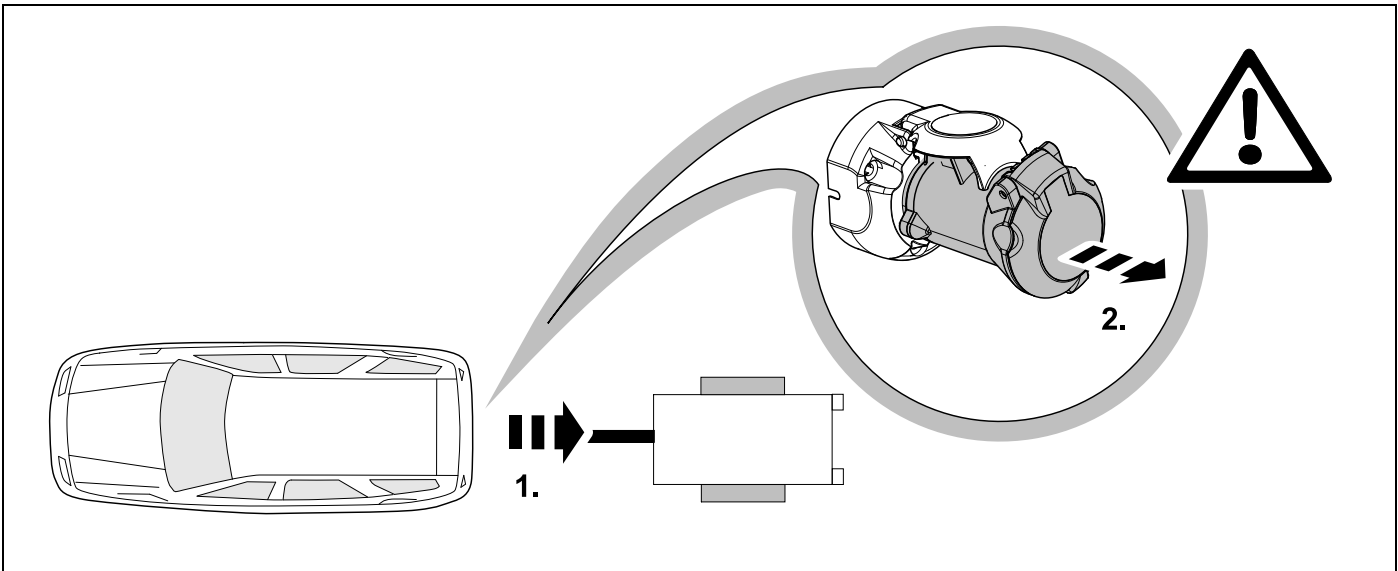
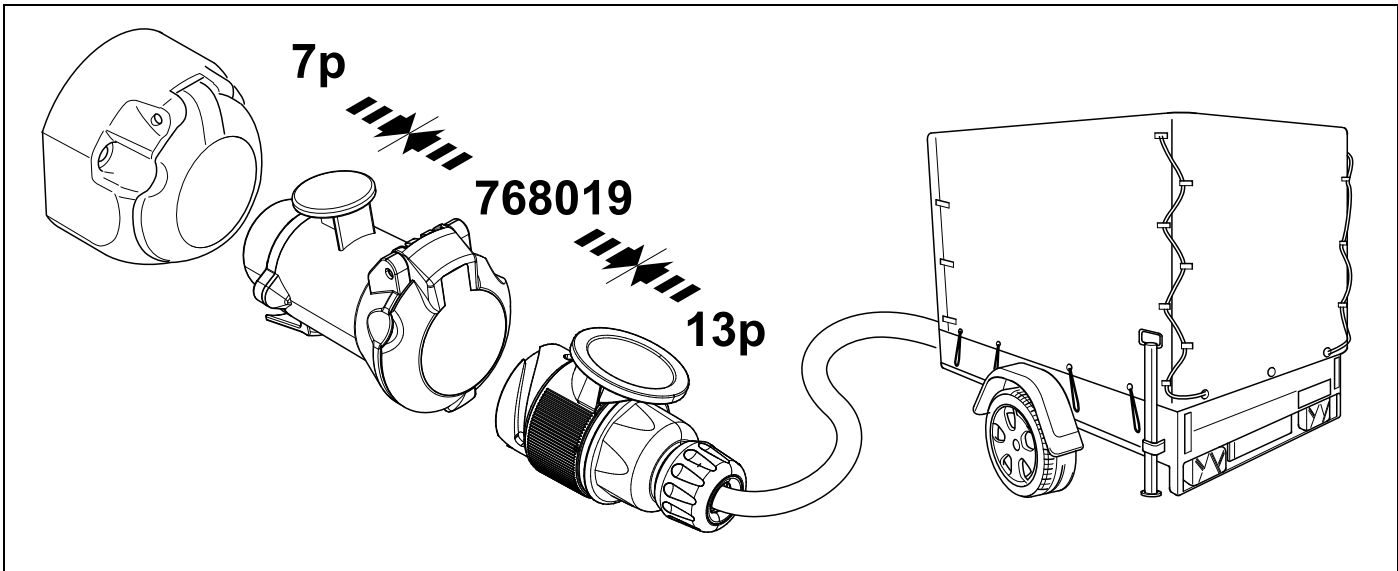
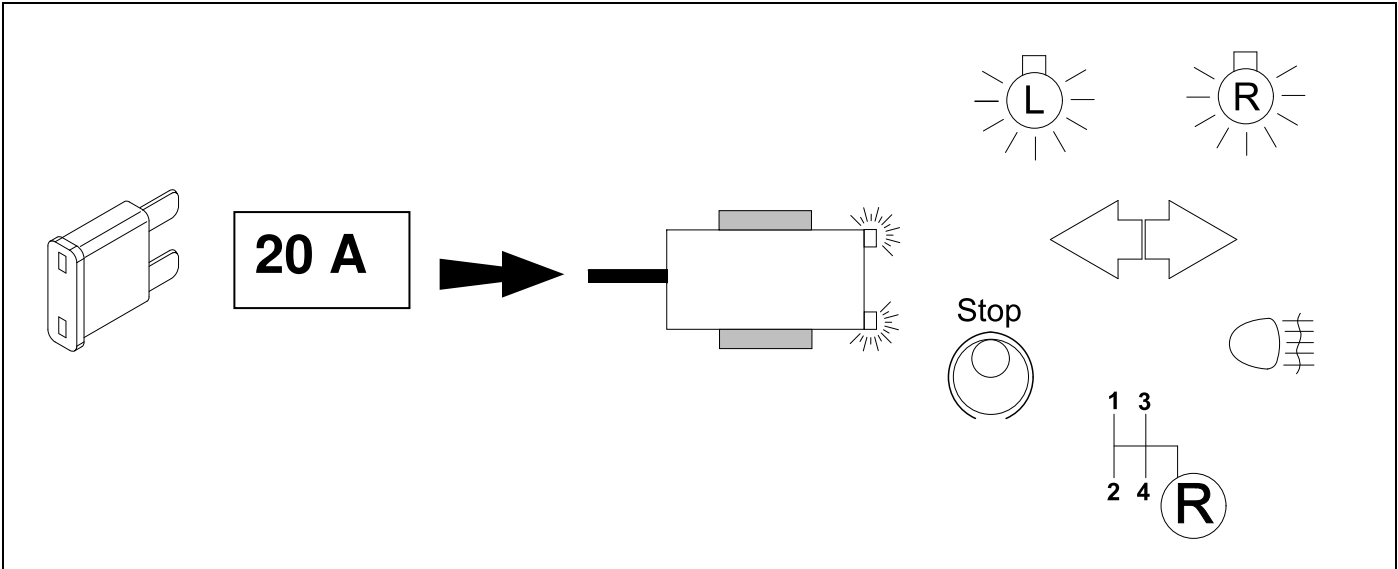



Service
Diagnostics Trailer Module:
Refer to the E-Kit Wiring Instruction

7

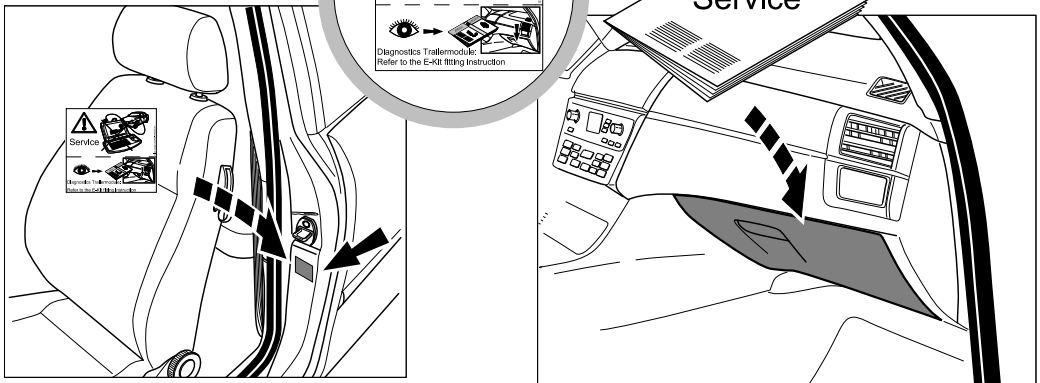
2x



Service
Diagnostics Trailer Module:
Refer to the E-Kit Wiring Instruction

Service

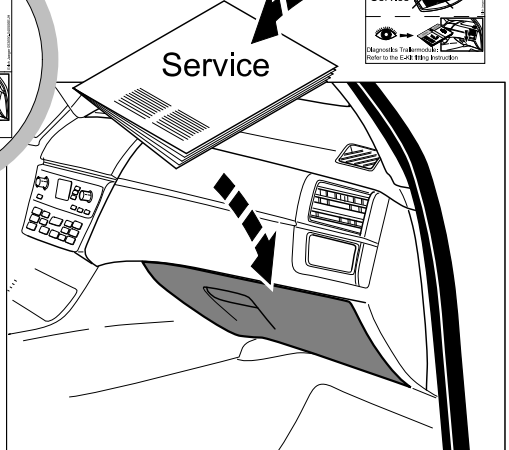

Service
Diagnostics Trailer Module:
Refer to the E-Kit Wiring Instruction

Status LED für Eigendiagnose

Status LED for self-diagnosis

Operation support

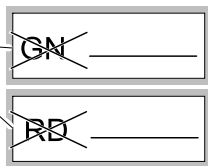
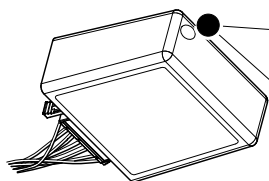
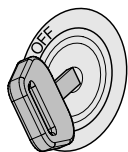

No CAN-Data =



Standby / Sleepmode



Ignition OFF

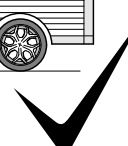
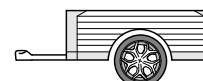
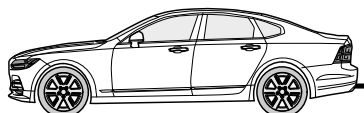
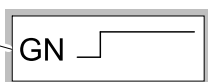
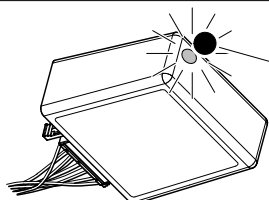

Ignition ON

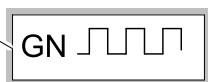
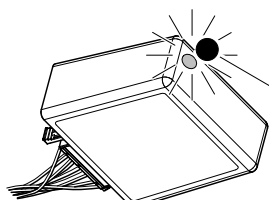

Ignition ON

Failure support

Check CAN-Data Wire

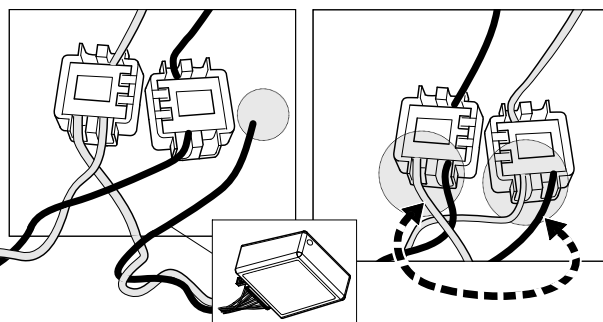
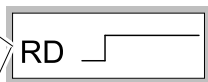
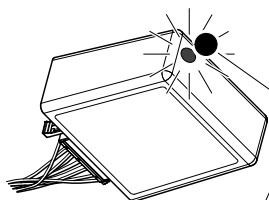

Ignition ON

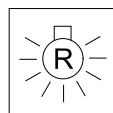
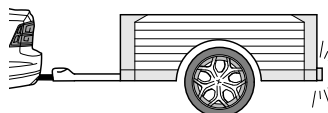

+

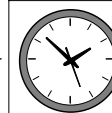
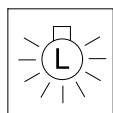

1x max 5 min.

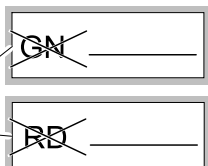
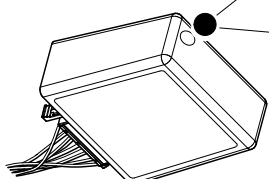

PIN 17

oder / or



PIN 1

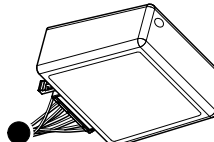
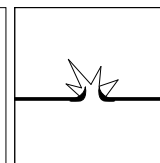
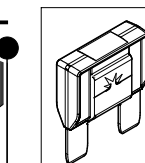
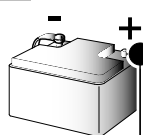

Ignition ON



<p>D Änderungen bezüglich Konstruktion, Ausstattung Farbe sowie Irrtum vorbehalten. Angaben und Abbildungen unverbindlich</p>	<p>PL Zastrzega się prawo do zmian dot. konstrukcji, wykończenia, kolorystyki oraz pomyłek. Dane i ilustracje niewiążące.</p>
<p>GB Subject to change in terms of construction, equipment and colour, and may contain errors. The information and illustrations are non-binding.</p>	<p>TR Tasarım, donanım ve renk bakımından değişiklik yapma hakkı ve hata ve eksiklik mahfuzdur. Veriler ve resimler bağlayıcı değildir.</p>
<p>F Sous réserve de modifications de la construction, de l'équipement, de la couleur et sous réserve d'erreurs. Les indications et les illustrations sont sans engagement.</p>	<p>H A szerkezet, a kivitelt és a szín változtatása, valamint a változások joga fenntartva. Az adatok és az ábrák nem kötelező érvényűek.</p>
<p>NL Wijzigingen met betrekking tot constructie, uitvoering en kleur evenals vergissingen voorbehouden. Gegevens en afbeeldingen zyn niet bindend.</p>	<p>HR Pravo promjena u svezi konstrukcije, opreme, boje kao i zabune oridžavamo. Podaci i ilustracije su neobavezne.</p>
<p>DK Ændringer med hensyn til konstruktion, udstyr, farver samt fejl forbeholdes. Oplysninger og illustrationer er uforpligtende.</p>	<p>BUL Запазени права по отношение на конструкцията, оборудването, цвета и грешки. Данните и изображенията не са обвързващи.</p>
<p>N Endringer angående konstruksjon, utstyr, farge og feiltagelse forbeholdes. Opplysninger og illustrasjoner uforbindtlig.</p>	<p>RO Ne rezervăm dreptul unor modificări ale construcției, dotării, culorii și dreptul la erori Datele indicate și imaginile sunt orientative.</p>
<p>S Med reservation för ändringar vad det gäller konstruktion, utrustning, färg samt för misstag. Uppgifterna och bilderna är inte bindande.</p>	<p>RU Права на внесение изменений относительно конструкции, оснащения, окраски, а также на ошибки сохраняются. Данные и иллюстрации имеют примерный характер.</p>
<p>FIN Pidätämme oikeuden rakennetta, varustusta, väriä koskeviin sekä erehdyksestä johtuviin muutoksiin. Tiedot ja kuvat eivät ole sitovia.</p>	<p>LT Pasiliekaama konstrukcijos, įrangos bei reikmenų, spalvos pakeitimų ir klaidų teisė. Duomenys ir iliustracijos neįpareigojantys.</p>
<p>I Con riserva di modifiche relative a progettazione, dotazione, colore ed errori. Le indicazioni e figure sono fornite senza impegno.</p>	<p>LV Tiek paturētas tiesības uz konstrukcijas, iekārtu, krāsu izmaiņām, kā arī kļūdīšanās. Dati un attēli bez saistībām.</p>
<p>E Reservadas las modificaciones respecto a diseño, equipamiento, color, así como error. Indicaciones y figuras sin compromiso.</p>	<p>EST Konstruktsiooni, varustuse ja võervi osas muudatused ning eksimine lubatud. Andmed ja joonised on mittesiduvad.</p>
<p>P Reservamos o direito de alterações relativamente ao desenho, equipamento, cor, bem como de erro. Os dados e as gravuras não implicam compromisso da nossa parte.</p>	<p>SLO Zadržana pravica do sprememb glede konstrukcije, opreme, barve ter pomote. Podatki in slike so neobvezne.</p>
<p>GR Διατηρώνουμε κάθε επιφύλαξη ως προς αλλαγές σε σχέση με κατασκευή, εξοπλισμό, διαρρυθμίση, χρωματισμούς και λάθη παραδρομής.</p>	<p>SK Zmeny, ktoré sa týkajú konštrukcie, vybavenia, farby, ako aj omyly sú vyhradené. Údaje a zobrazenia sú nezáväzné.</p>
<p>CZ Změny, týkající se konstrukce, vybavení, barvy, jakož i omyly jsou vyhrazeny. Údaje a vyobrazení jsou nezávazné.</p>	